



McIntosh Laboratory, Inc. 2 Chambers Street Binghamton, New York 13903-2699 Phone: 607-723-3512 www.mcintoshlabs.com

MC830

Power Amplifier
Owner's Manual





The MC830 Power Amplifier is the latest McIntosh accomplishment in long tradition of uncompromising quality and leadership in sound amplification. Combining the latest cutting edge technology with a proven history of innovation, the MC830 will provide you an unsurpassed sonic experience.

Thank you from all of us at McIntosh

With the MC830 Amplifier, you have invested in a precision instrument that will provide you with many years of enjoyment. Please take a few moments to familiarize yourself with the features and instructions to get the maximum performance from your equipment.

If you need further technical assistance, please contact your dealer who may be more familiar with your particular setup including other brands. You can also contact McIntosh with additional questions or in the unlikely event of needing service.

McIntosh Laboratory, Inc.

2 Chambers Street
Binghamton, New York 13903

Technical Assistance: (607) 723-3512

Customer Service: (607) 723-3515

Fax: (607) 724-0549

Email: support@mcintoshlabs.com

Website: mcintoshlabs.com

Make a Note

For future reference, you can jot down your serial number and purchase information here. We can identify your purchase from this information if the occasion should arise.

Serial Number:	
Purchase Date:	
Dealer Name	

Safety First

Important Safety Information is supplied in a separate document “Important Additional Operation Information Guide”

Table of Contents

Thank you from all of us at McIntosh	2
Make a Note	2
Safety First	2
Where to put it	4
Connection Diagram.....	5
Connections on the Back	6
The Inputs	6
The Outputs	6
Making Connections.....	6
Pick an Input.....	6
Connecting a Loudspeaker.....	6
The Speaker Wire	7
Connecting to the Binding Posts	7
Auto Off.....	8
Sentry Monitor.....	8
The Front Panel.....	8
The Left Knob	8
The Meter.....	8
The Right Knob	8
The Power Guard® LED	8
The Standby LED	8
Packing the MC830.....	10
Specifications	11

List of Figures

Figure 01– MC830 Dimensions	4
Figure 02– Ventilation requirements	4
Figure 03– MC830 Rear View.....	6
Figure 04– RCA Connector.....	6
Figure 05– XLR Connector.....	6
Figure 06– XLR pin diagram	7
Figure 07– Loudspeaker Wire Gauge Guide.....	7
Figure 08– Opening Binding Post.....	7
Figure 09– Tightening Binding Post	7
Figure 10– Mini plug for Power Control (Trigger).....	7
Figure 11– Front Panel.....	9
Figure 12– Re-packing diagram.....	10



Where to put it

The MC830 can be placed upright on a table or shelf, standing on its four feet. It also can be custom installed in a piece of furniture or cabinet.

Always provide adequate ventilation for your MC830. Cool operation ensures the longest possible operating life for any electronic instrument. Do not install the MC830 directly above other heat generating

component such as a high-powered amplifier. If all the components are installed in a single cabinet, a quiet running ventilation fan can be a definite asset in maintaining all the system components at the coolest possible operating temperature.

A custom cabinet installation should provide the following minimum spacing dimensions for cool operation (See Figure 02 on page 4):

- 6 inches (15.3cm) above the top
- 5/8 inches (1.6cm) below the bottom

- 2 inches (5.1cm) on each side of the MC830 so that airflow is not obstructed
- 18 inches (45.7cm) depth behind the front panel
- 1-7/16 inch (3.7cm) in front of the mounting panel for knob clearance

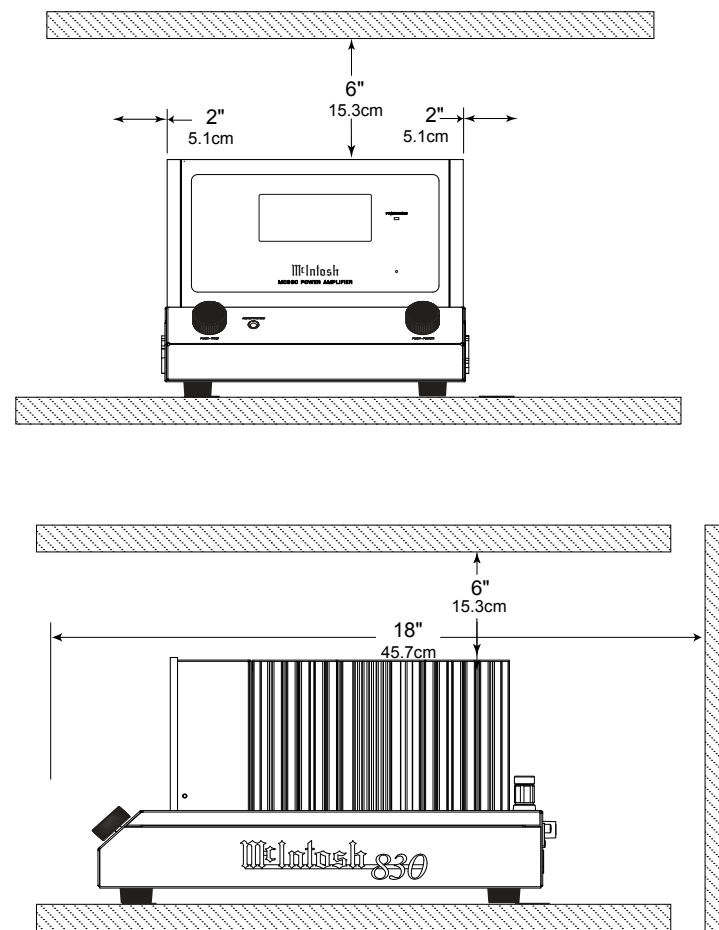
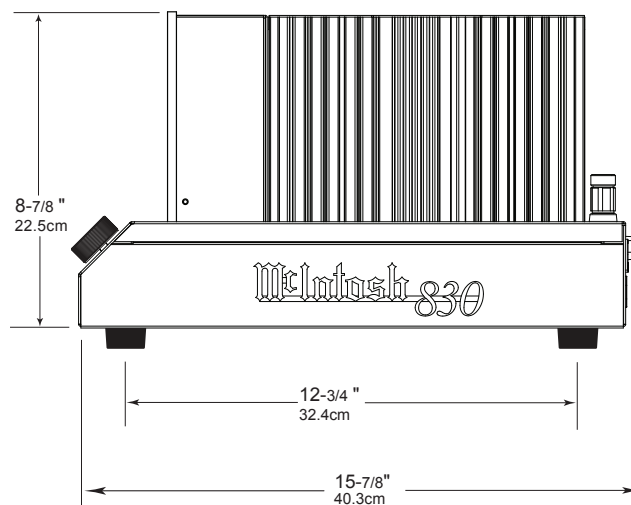
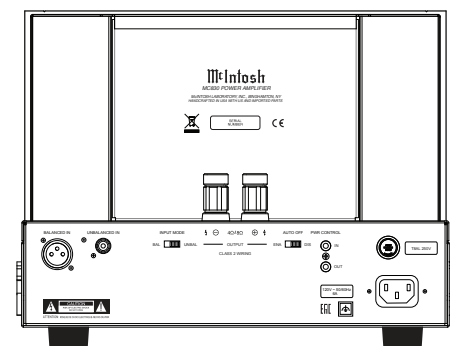
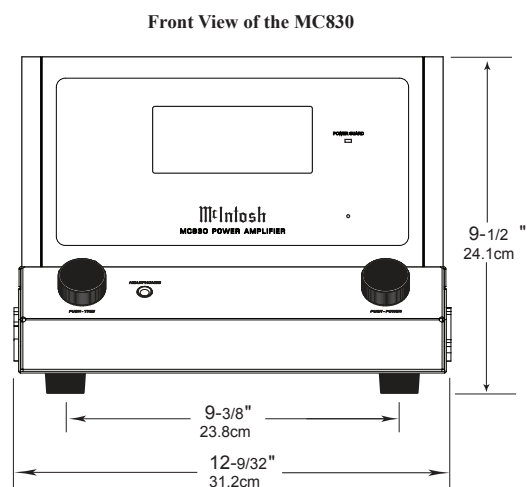

Figure 01– MC830 Dimensions

Figure 02– Ventilation requirements



Connection Diagram

Since the MC830 is a mono amplifier, a stereo setup will require two MC830 amplifiers. Connect one MC830 to the right preamplifier output and right Loudspeaker and one MC830 to the left preamplifier output and left Loudspeaker as shown here.

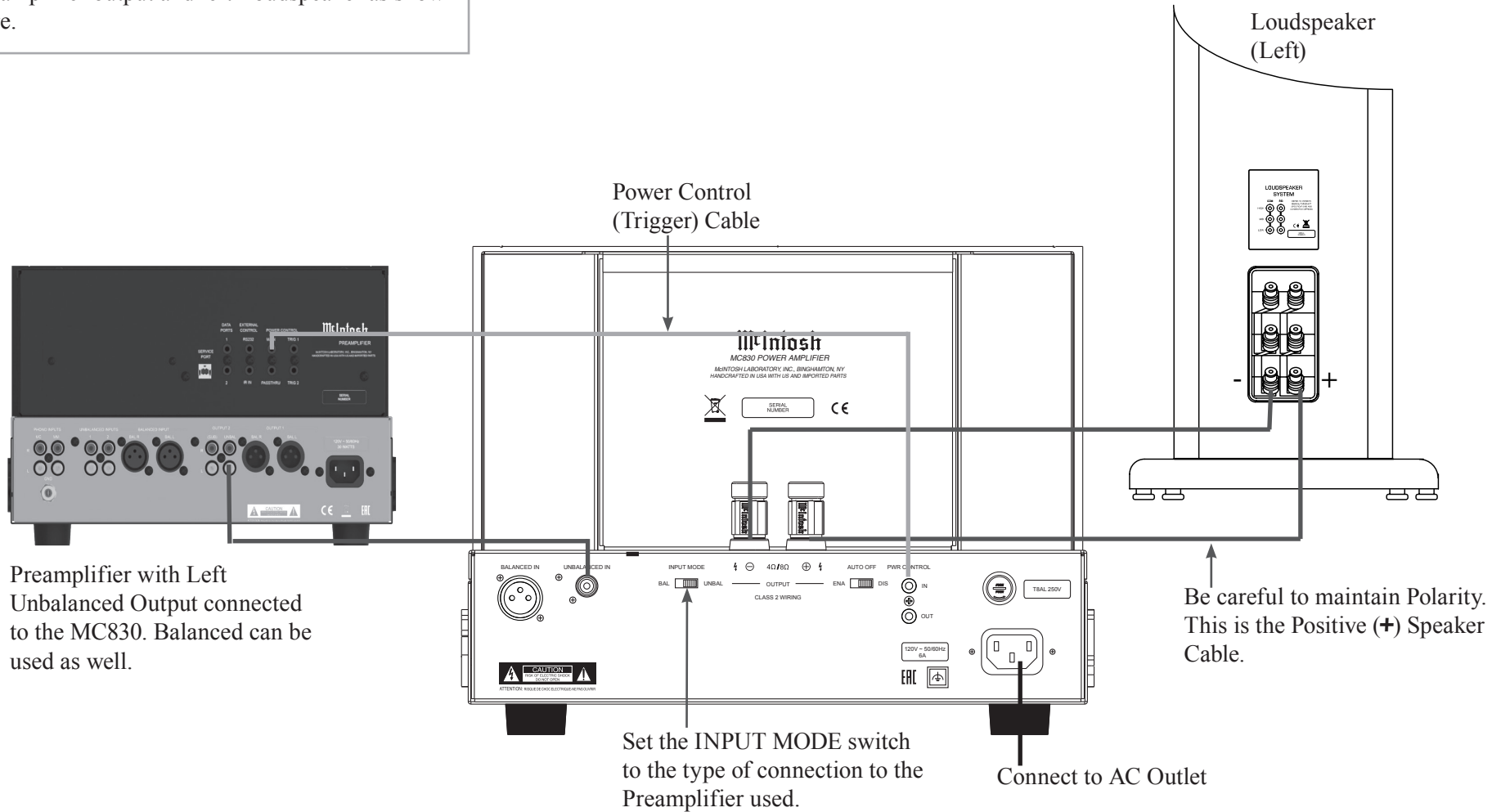



Solid Cinch™ Speaker Binding Posts
Positive and Negative terminals for
connecting 4 or 8 Ohm Loudspeakers.
Pay attention to the polarity labeled + and -

INPUT MODE Switch
Selects Balanced or Unbalanced Input
to amplify

Unbalanced Input
(UNBALANCED IN) for an RCA cable
from a Preamplifier or A/V Processor
audio output

Balanced Input
(BALANCED IN) for an XLR cable from
a Preamplifier or A/V Processor audio
output

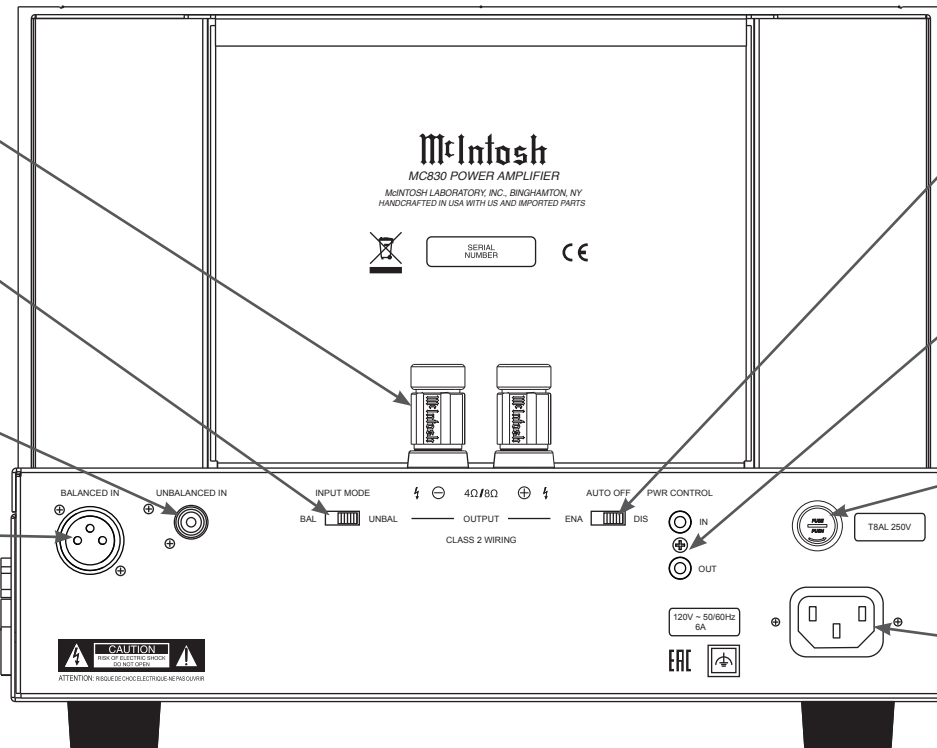

AUTO OFF Switch
Enables (ENA) or Disables (DIS) the
Auto Off feature. When enabled the
MC830 will Power Off if no input is
received for 30 minutes. (When Power
Control Knob is in the ON position)

POWER CONTROL
IN receives power On/Off signals from a McIntosh
component
OUT sends power On/Off signals to a connected
McIntosh component

Fuse Holder
Look at the back panel of your MC830 to
determine the correct fuse size and rating
and refer to the included Important Additional
Operation Information Guide for more information

AC POWER
Use supplied AC Power Cord to connect to a
live AC outlet after other connections have been
made

Figure 03– MC830 Rear View

Connections on the Back

The Inputs

- One UNBALANCED input- RCA Jack
- One BALANCED XLR input
- One 1/8-inch jack Power Control (trigger) Input
- One AC power connector

The Outputs

- Two McIntosh gold plated Binding Posts
- One 1/8-inch jack Power Control (trigger) Output

Making Connections

Pick an Input

Choose the type of Input connection you wish to use either BALANCED (XLR cable see Figure 05) or UNBALANCED (RCA cable see Figure 04). Set the **INPUT MODE** Switch to the type of Input you wish to use. Slide the Switch towards BAL for the BALANCED IN connection or UNBAL for the UNBALANCED IN connection.

Using the cable appropriate to the Input you have chosen, connect the MC830 to your Preamplifier. Typically, the mono MC830 will be used in pairs for a stereo setup. If this is the case, pay attention to



Figure 04– RCA Connector Figure 05– XLR Connector

which MC830 is connected to the left and which is connected to the right output of the Preamplifier. “Figure 06– XLR pin diagram” on page 7 shows the proper Pin configuration for an XLR Balanced connection to the MC830.

Connecting a Loudspeaker

The MC830 is designed to power a four or eight Ohm Loudspeaker. You will need quality speaker wire.

PIN 1: Shield/Ground
 PIN 2: + Signal
 PIN 3: - Signal

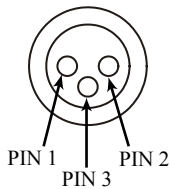

Figure 06– XLR pin diagram

The Speaker Wire

If speaker wire is not already terminated, remove ½ inch (12.7mm) of insulation from the wire end and twist the strands together. For runs under 25 feet (7.6m), use at least 16AWG wire. For runs under 50 feet (15.2m) use at least 14AWG, and for longer runs up to 100 feet (30.5m), use 12AWG. 12AWG, being the larger wire, can be used in all the above cases if desired. The above guidelines are for 8 Ohm connections. When using 4 Ohm speaker connections, subtract 2 from the gauge. For example, a minimum gauge for a 50 foot 4 Ohm run would be 12AWG. For guide, see Figure 07.

Generally, thicker gauge wire is better than thinner until it doesn't fit in the Binding Post's hole.

Loudspeaker Wire Gauge Guide			
Impedance	25 feet (7.62 meters) or less	50 feet (15.24 meters) or less	100 feet (30.48 meters) or less
4 Ohms	14AWG	12AWG	10AWG
8 Ohms	16AWG	14AWG	12AWG

Figure 07– Loudspeaker Wire Gauge Guide

Connecting to the Binding Posts

McIntosh patented gold-plated Solid Cinch™ Speaker Binding posts assure the best connection to all speaker cables.

When connecting the speaker wire to the MC830's Binding Posts, please follow these steps:

- Make sure AC Power is disconnected
- Pay close attention to the Polarity (+/-). **Proper Polarity must be maintained for all connections**
- Rotate the end of the Binding Post counterclockwise until an opening appears (see Figure 09).

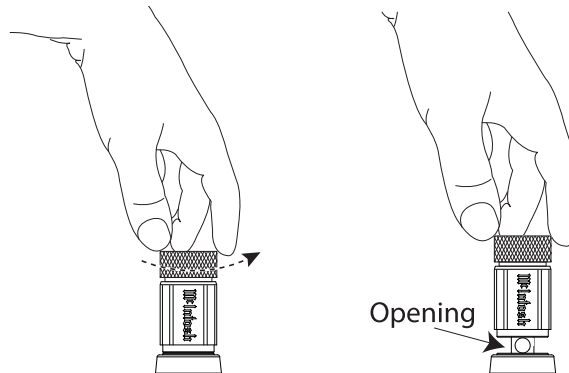

Figure 08– Opening Binding Post

- Insert the Loudspeaker hookup cable into the Binding Post's opening or the cable spade lug around the center post of the Binding Post (see Figure 09).
- Rotate the end of the Binding Post clockwise until it is finger tight
- Attach the supplied McIntosh Wrench to the top of the Binding Post using either set of three prongs. One set of three prongs is at the very end of the Wrench and the other set is located 90° from there. Either set will

work. Fit the prongs in the holes on the top of the Binding Post. The larger prong will fit in the center hole. Rotate the Binding Post one quarter of a turn (90°) to secure the Loudspeaker cable connection (see Figure 10). **Do not over tighten**

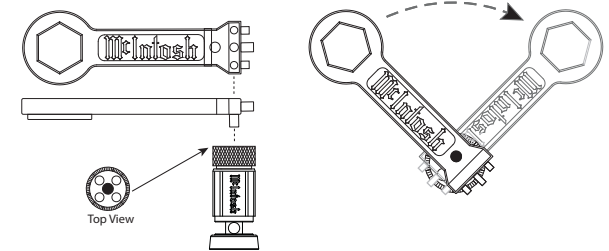

Figure 09– Tightening Binding Post

Power Control (Trigger) Outputs

Power Control allows the MC830 to send (OUT) and receive (IN) On/Off signals to/from other McIntosh equipment. In this way, powering on or powering off a single component can do the same for multiple units.

The Power Control Input Jack (PWR CONTROL IN) accepts an On/Off signal from +5 to +12 volts. The Power Control Output will provide a +12 volt signal with a total current up to 25 mA. Connections are made using an 1/8 inch stereo mini phone plug with the following wiring:

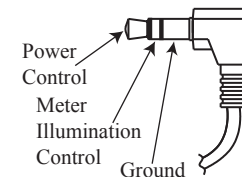

Figure 10– Mini plug for Power Control (Trigger)

The MC830's Meter Light can be controlled by a connected McIntosh Preamplifier connected through



the PWR CONTROL IN jack. When the Meter Control Knob is in the WATTS or HOLD position, “The Left Knob” on page 8, the MC830 will follow an On or Off signal for the Meter light from a connected Preamplifier (or A/V Control Center).

AC Power

This connection is essential. Plug the female end of the supplied AC Power Cord into the AC connector (standard 15 ampere IEC) located in the rear right corner of the MC830. Plug the male end of the AC Power Cord into a grounded and functioning AC outlet.

Auto Off

This switch Enables (ENA) or Disables (DIS) the Auto Off feature. When the Auto Off feature is enabled the MC830 will Power Off if no input is received for 30 minutes if the Power Control Knob (Right Knob) is in the ON position. When the Power Control Knob is in the REMOTE position, the MC830 will follow the power status of the unit connected to the PWR CONTROL IN jack.

Sentry Monitor

The MC830 incorporates McIntosh’s patented Sentry Monitor output transistor protection circuit. Built-in thermal protection circuits guard against overheating. There is absolutely no compromise in sonic performance with this circuit, and it ensures safe operation of the amplifier under even the most extreme operating conditions, and contributes to a long safe operating life of the MC830.

The Front Panel

The MC830’s glass and metal Front Panel provides two control knobs and an Illuminated Power Meter. There are also two status indicator LEDs.

The Left Knob

The Left Knob is also called the **Meter Control Knob**. The Meter Control Knob has three switch positions:

- **LIGHTS OFF**- the Meter light will be off. The Meter will still respond to output
- **WATTS**- the Meter responds to all output and the Meter Light is on unless controlled by another unit as noted below
- **HOLD**- the Meter needle will lock on the highest peak in a series of peaks. When a higher peak is reached, the needle will hold that value. If no greater power level is reached, the needle will lower its level at a rate of approximately 6dB per minute returning to a lower power peak or resting position

Note that when in the WATTS or HOLD position, the Meter Light will be powered On or Off by a Preamplifier (or A/V Control Center) connected by a Power Control Cable if that unit has Power Control capabilities.

The Meter

The MC830’s Meter provides an accurate measurement of power to safely know what wattage is sent to the attached speakers, and thus, providing the knowledge to avoid any potential damage caused by exceeding the speaker’s power limitation.

The top numbers show the MC830’s output in Watts for an 8 Ohm connected Loudspeaker. The bottom numbers are for a 4 Ohm connected Loudspeaker. A logarithmic scale is used to provide visibly useful movement at low volumes.

The Right Knob

The Right Knob is also known as the **Power Control Knob**. The Power Control Knob has three switch positions:

- **OFF**- the MC830 will Power Off no matter what signal may be received from a unit connected by a Power Control cable
- **REMOTE**- the MC830 can be powered On and Off by a Preamplifier or A/V Control Center connected by a Power Control Cable. (See “Power Control (Trigger) Outputs” on page 7.)
- **ON**- this position will Power the MC830 On

The Power Guard® LED

Power Guard® continuously monitors input and output signals and can dynamically adjust input levels to insure maximum output while avoiding harsh clipping or distortion. Patented Power Guard® technology allows its circuitry to remain completely outside the signal path unless needed. When Power Guard is engaged, the effect is very subtle especially when compared with clipping and distortion of other overdriven Amplifiers. Power Guard’s amber LED indicates by flashing when Power Guard® is engaged.

The Standby LED

The Standby LED will glow red anytime the MC830 is connected to a live AC outlet.



Figure 11- Front Panel



Packing the MC830

When shipping the MC830, it is highly recommended that the unit be packed as it was originally shipped to avoid damage. Failure to properly pack the unit will likely result in damage. (The front panel is made of glass!) If you need any of the packing material, you can contact McIntosh Customer Service. Use only packing material that is in good condition and replace any material that has seen better days.

It is very important that the four plastic feet are properly placed in the holes of the Foam Bottom Pad. This will ensure the proper equipment location for shipping. Failure to do this will result in shipping damage.

<u>Quantity</u>	<u>Part Number</u>	<u>Description</u>
1	034661	Shipping carton only
1	034654	Foam Pad Bottom
1	034660	Foam Top Cover
1	033656	Foam Ring
1	033657	Foam Upper Ring
1	034659	Foam Ring
1	034655	Foam Top Pad

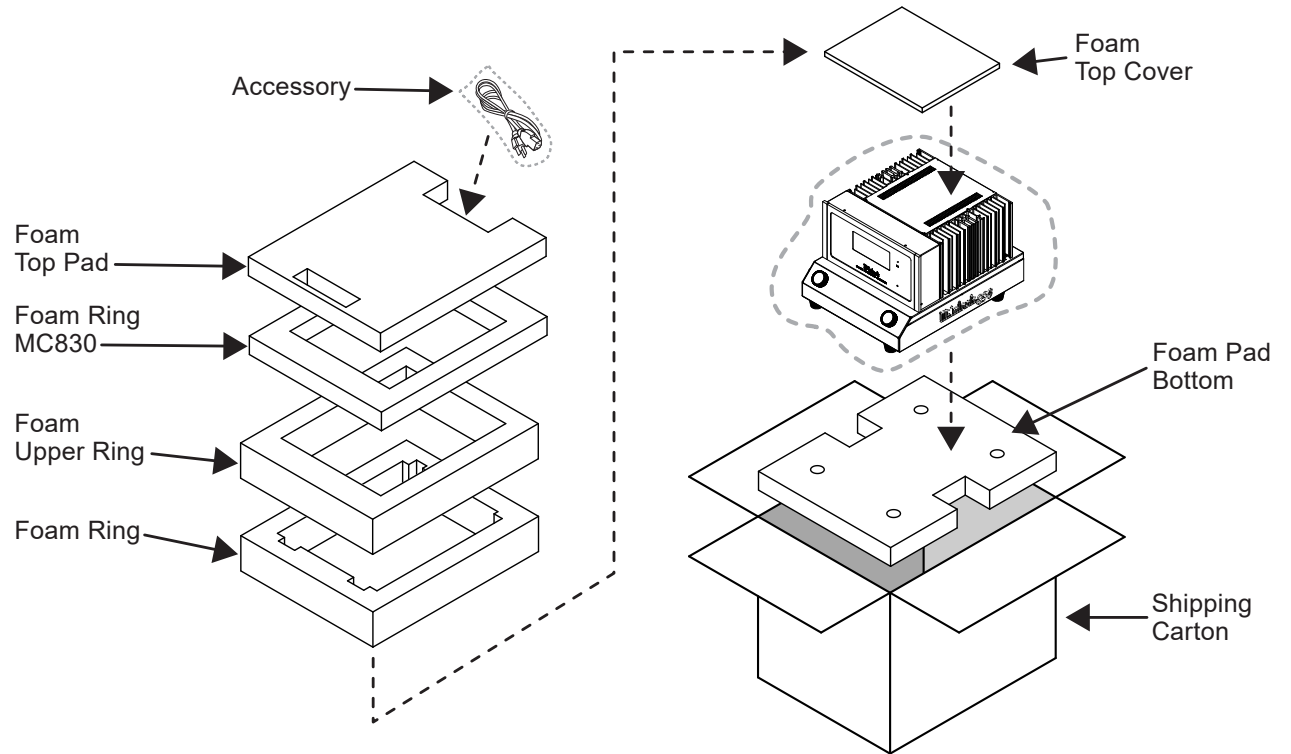

Figure 12– Re-packing diagram

Specifications

Power Output

300 watts into 8 Ohm load
480 watts into 4 Ohm load

Output Load Impedance

4 or 8 Ohm

Rated Power Band

20Hz to 20,000Hz

Dynamic Headroom

2dB

Wide Band Damping Factor

Greater than 100

Frequency Response

+0, -0.25dB from 20Hz to 20,000Hz
+0, -3.0dB from 10Hz to 100,000Hz

Total Harmonic Distortion

0.005% maximum harmonic distortion at any power level from 250 milliwatts to rated power, 20Hz to 20,000Hz

Intermodulation Distortion

0.005% maximum, if the instantaneous peak power output does not exceed twice the rated power output for any combination of frequencies from 20Hz to 20,000Hz

Signal To Noise Ratio (A Weighted)

120dB Balanced (below rated output)
118dB Unbalanced (below rated output)

Input Sensitivity (for 300 watts in 8 Ohms)

3.4 Volts Balanced
1.7 Volts Unbalanced

Voltage Gain

29dB

Input Impedance

22,000 Ohms Balanced
22,000 Ohms Unbalanced

Power Guard

Less than 2% Total Harmonic Distortion with up to a 14dB overdrive signal

Power Control Input

5-15VDC, less than 1mA

Power Control Output

12VDC, 25mA (Delayed 0.2 seconds from power on)

Power Requirements

100 Volts ~ 50/60Hz at 7.2 Amps
110 Volts ~ 50/60Hz at 6.0 Amps
120 Volts ~ 50/60Hz at 6.0 Amps
127 Volts ~ 50/60Hz at 3.7 Amps
220 Volts ~ 50/60Hz at 3.3 Amps
230 Volts ~ 50/60Hz at 3.3 Amps
240 Volts ~ 50/60Hz at 3.3 Amps
Standby, less than 0.5 watt

Refer to the rear panel of the MC830 for the correct voltage.

Overall Dimensions

Width is 12-9/32 inches (31.2cm)
Height is 9-1/2 inches (24.1cm) including feet
Depth is 16 inches (40.6cm)

Weight

48 pounds (21.8Kg) net, 55 pounds (24.9Kg) in shipping carton

Shipping Carton Dimensions

Width is 20-3/8 inches (51.8cm)
Height is 13-1/4 inches (33.7cm)
Depth is 16-1/4 inches (41.3cm)



The continuous improvement of its products is the policy of McIntosh Laboratory Incorporated who reserve the right to improve design without notice.

Printed in the U.S.A.

McIntosh Part No. 24110400