



McIntosh Laboratory, Inc. 2 Chambers Street Binghamton, New York 13903-2699 Phone: 607-723-3512 [www.mcintoshlabs.com](http://www.mcintoshlabs.com)

C8

Tube Preamplifier

Owner's Manual





**The C8 Tube Preamplifier marries McIntosh’s long tradition of uncompromising quality and leadership in Vacuum Tube amplification with the latest cutting edge innovations to bring you an unsurpassed luxury sonic experience.**

---

## **Thank you from all of us at McIntosh**

---

With the C8 Tube Preamplifier, you have invested in a precision instrument that will provide you with many years of enjoyment. Please take a few moments to familiarize yourself with the features and instructions to get the maximum performance from your equipment.

If you need further technical assistance, please contact your dealer who may be more familiar with your particular setup including other brands. You can also contact McIntosh with additional questions or in the unlikely event of needing service.

**McIntosh Laboratory, Inc.**  
2 Chambers Street  
Binghamton, New York 13903

Technical Assistance: (607) 723-3512  
Customer Service: (607) 723-3515  
Fax: (607) 724-0549  
Email: [support@mcintoshlabs.com](mailto:support@mcintoshlabs.com)  
Website: [mcintoshlabs.com](http://mcintoshlabs.com)

---

## **Make a Note**

---

For future reference, you can jot down your serial number and purchase information here. We can identify your purchase from this information if the occasion should arise.

Serial Number:	
Purchase Date:	
Dealer Name	

---

## **Safety First**

---

**Important Safety Information is supplied in a separate document “Important Additional Operation Information Guide”**

## Table of Contents

Thank you from all of us at McIntosh .....	2
Make a Note .....	2
Safety First .....	2
Remove the Foam .....	4
Where to put it .....	6
The Front Panel .....	7
The Left Knob .....	7
The Right Knob .....	7
Connections on the Back .....	8
The Inputs .....	8
The Outputs .....	8
Making Connections .....	8
Phono/Unbalanced Inputs .....	8
Balanced/XLR Input and Output .....	9
RS232 .....	9
Wired IR Input .....	9
Connection Diagram .....	10
DA2 Expansion Slot .....	11
Power Control (Trigger) Outputs .....	11
Data Out .....	11
Power On the C8 .....	12
Trim Functions and Settings .....	12
Phono Trim Function .....	12
Setup Settings .....	13
Firmware and Serial Number .....	13
Input Setup .....	13
Output 2 (SUB) .....	13
Trigger Setup .....	13
Data Port Setup .....	14
Passthru .....	14
RS232 Setup .....	14
IR Codes Setup .....	14
Front IR Setup .....	14
Auto-Off Setup .....	15
FACTORY RESET .....	15
Remote Control Buttons .....	16

Changing the Remote's Battery .....	17
Packing the C8 .....	18
Specifications .....	19

## List of Figures

Figure 01– C8 Dimensions .....	6
Figure 02– Ventilation requirements .....	6
Figure 03– Front Panel .....	7
Figure 04– C8 Rear View .....	8
Figure 05– RCA/Phono Plugs .....	9
Figure 06– XLR pin diagram .....	9
Figure 07– Mini plug for RS232 connection .....	9
Figure 08– DB9 connector pin layout .....	9
Figure 09– IR 3.5mm connector .....	9
Figure 10– Power control (trigger) mini plug .....	11
Figure 11– 3.5mm Data plug .....	12
Figure 12– Inputs Menu .....	13
Figure 13– Opening the Remote Control .....	17
Figure 14– Re-packing diagram .....	18

# IMPORTANT!

**INSTRUCTIONS FOR REMOVAL OF  
FOAM INSERT OVER THE VACUUM  
TUBES PRIOR TO CONNECTING THE  
A.C. POWER SUPPLY CORD, START  
ON THE NEXT PAGE.**



## Remove the Foam

**Caution:** To prevent damage to the C8 Tubes during shipping, there is a special foam insert surrounding the Tubes of the Preamp.

**The Foam Insert must be removed from the C8 before connecting the AC Power Supply Cord to the Preamp.**

**Failure to do so has the potential of a Fire Hazard, resulting in damage to the C8 and the surrounding environment.**

**Follow these instructions for removal of the packing foam before connecting the AC Power Supply Cord to the C8.**

The C8 has no user serviceable parts, including the tubes. If repairs are needed they must be performed by an authorized McIntosh Service Agency. Follow the steps below to prepare the C8 for operation:

1. Orient the C8 so the Front and Top of the Preamp is facing you. Refer to Figure A.

2. Remove the Warning Sheet and save it with the Shipping Carton for possible future use. Refer to Figures A and B.

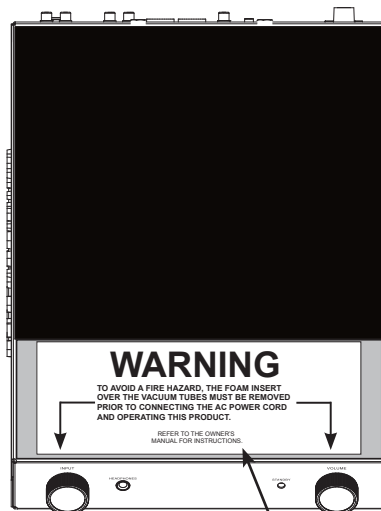

Figure A

Remove the Warning Sheet

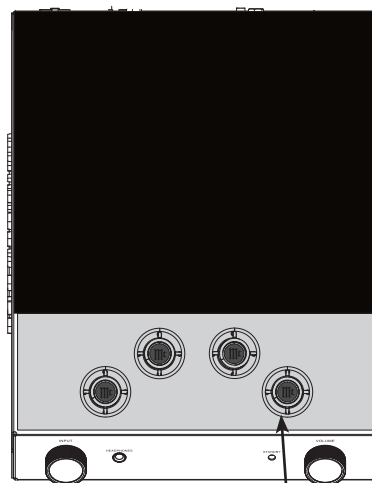

Figure B

Vacuum Tube Shield Covers

3. Carefully lift upright the Foam Insert Vacuum Tube Cover and place it near to the C8 Preamp. Refer to Figure C.

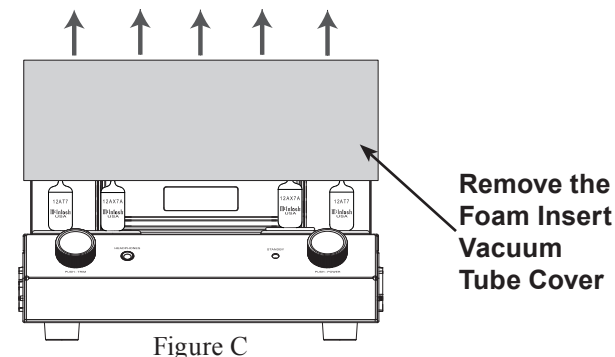

Figure C

4. Remove from the Foam, the four Vacuum Tube Shield Covers and place them along the side of the C8 Preamp. Save the Foam Insert Vacuum Tube Cover with the Shipping Carton for possible future use. Refer to Figure D.

Remove the four Vacuum Tube Shield Covers

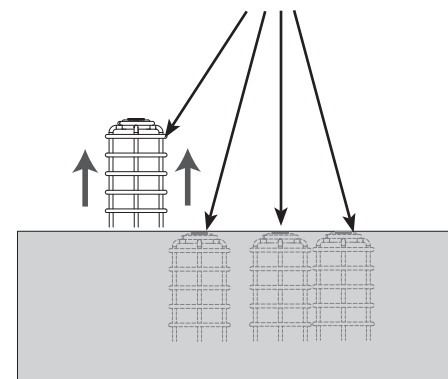

Figure D

## WARNING:

**The supplied Vacuum Tube Shield Covers must be installed over each of the four Small Vacuum Tubes before the C8 Preamplifier is connected to AC Power and activated for use!!**

**Failure to do so has the potential to cause physical harm to human beings and animals.**

**This could also result in damage to the Vacuum Tubes and the C8 Internal Circuitry.**

**It also prevents the potential of a Fire Hazard, resulting in damage to the C8 and the surrounding environment.**

5. The C8 Preamplifier has four Small Vacuum Tubes that are inserted into special Vacuum Tube Sockets on the Stainless Steel Chassis. Refer to Figure E.

Each of the Tube Sockets have four pin openings to accept the Vacuum Tube Shield Covers. Refer to Figure F.

Carefully install the Vacuum Tube Shield Covers into each of the Vacuum Tube Sockets orienting the Shield so the “Mc” on top of the Shield is facing forward. Refer to Figures G and H.

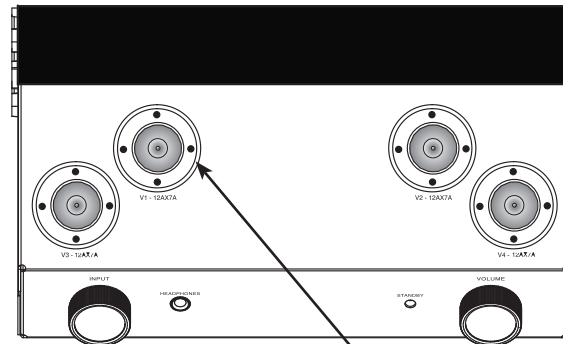

Figure E

Special Vacuum Tube Sockets

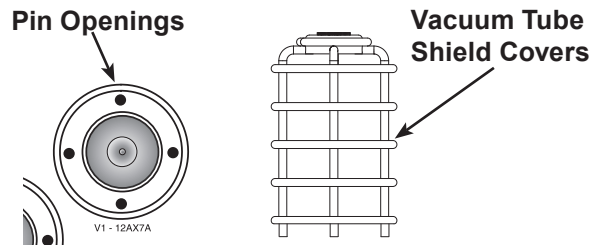

Figure F

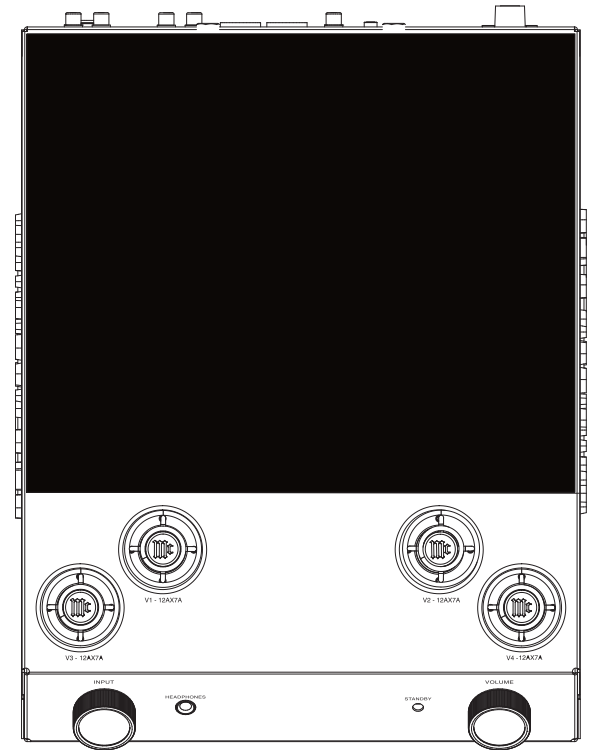

Figure G

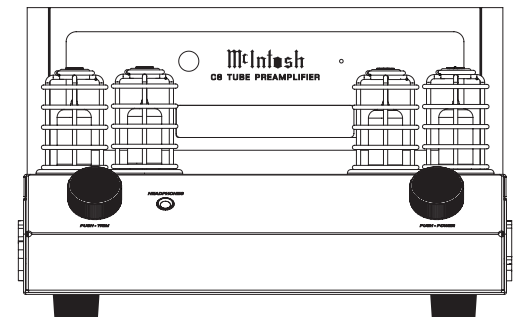

Figure H



## Where to put it

The C8 can be placed upright on a table or shelf, standing on its four feet. It also can be custom installed in a piece of furniture or cabinet.

Always provide adequate ventilation for your C8. Cool operation ensures the longest possible operating life for any electronic instrument. Do not install the C8 directly above a heat generating component such

as a high-powered amplifier. If all the components are installed in a single cabinet, a quiet running ventilation fan can be a definite asset in maintaining all the system components at the coolest possible operating temperature.

A custom cabinet installation should provide the following minimum spacing dimensions for cool operation (see Figure 02):

- 6 inches (15.3cm) above the top
- 5/8 inches (1.6cm) below the bottom

- 2 inches (5.1cm) on each side of the C8 so that airflow is not obstructed
- 18 inches (45.7cm) depth behind the front panel
- 1-7/16 inch (3.7cm) in front of the mounting panel for knob clearance

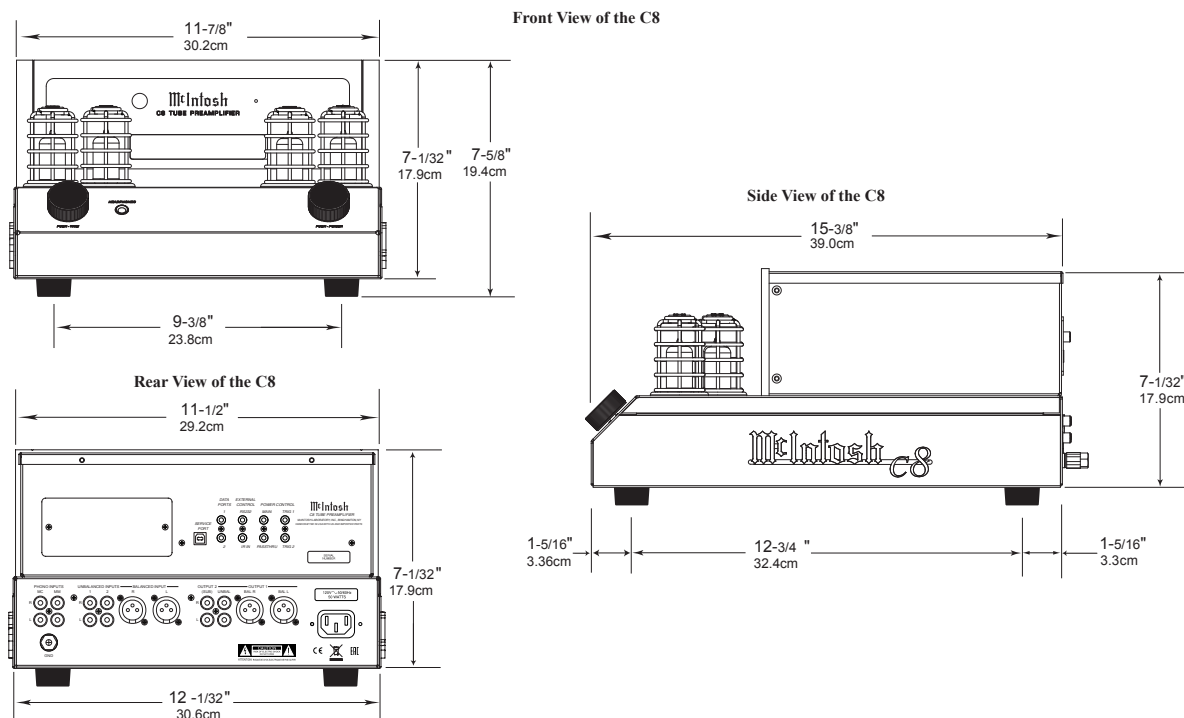

Figure 01- C8 Dimensions

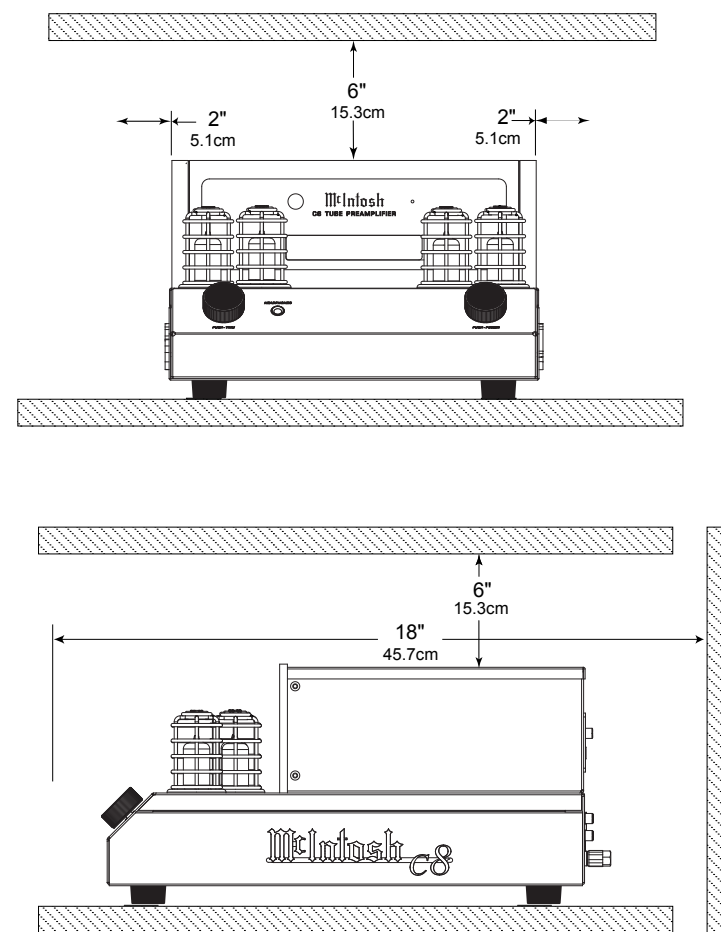

Figure 02- Ventilation requirements

## The Front Panel

The C8's glass and metal Front Panel provides two control knobs and an informational display (VFD).

### The Left Knob

The Left Knob, labeled INPUT, is used to change inputs, enter Trim setting mode and to enter Setup mode.

- Turn clockwise or counterclockwise to scroll through inputs
- Push and release to enter Trim Mode

- Push, hold and release after 2 seconds to enter Setup mode

### The Right Knob

The Right Knob, labeled VOLUME, is used to change the volume as well scroll through input values within Trim Mode. Push and release the knob to Power Off. Push the Right Knob to Power On when the C8 is off.

- Turn clockwise or counterclockwise to scroll through input values in Setup mode or Trim Mode

- Push and release to Power On when C8 is Off
- Push and release to Power Off.

The Standby Indicator LED will glow red as long as AC Power is connected to the C8.

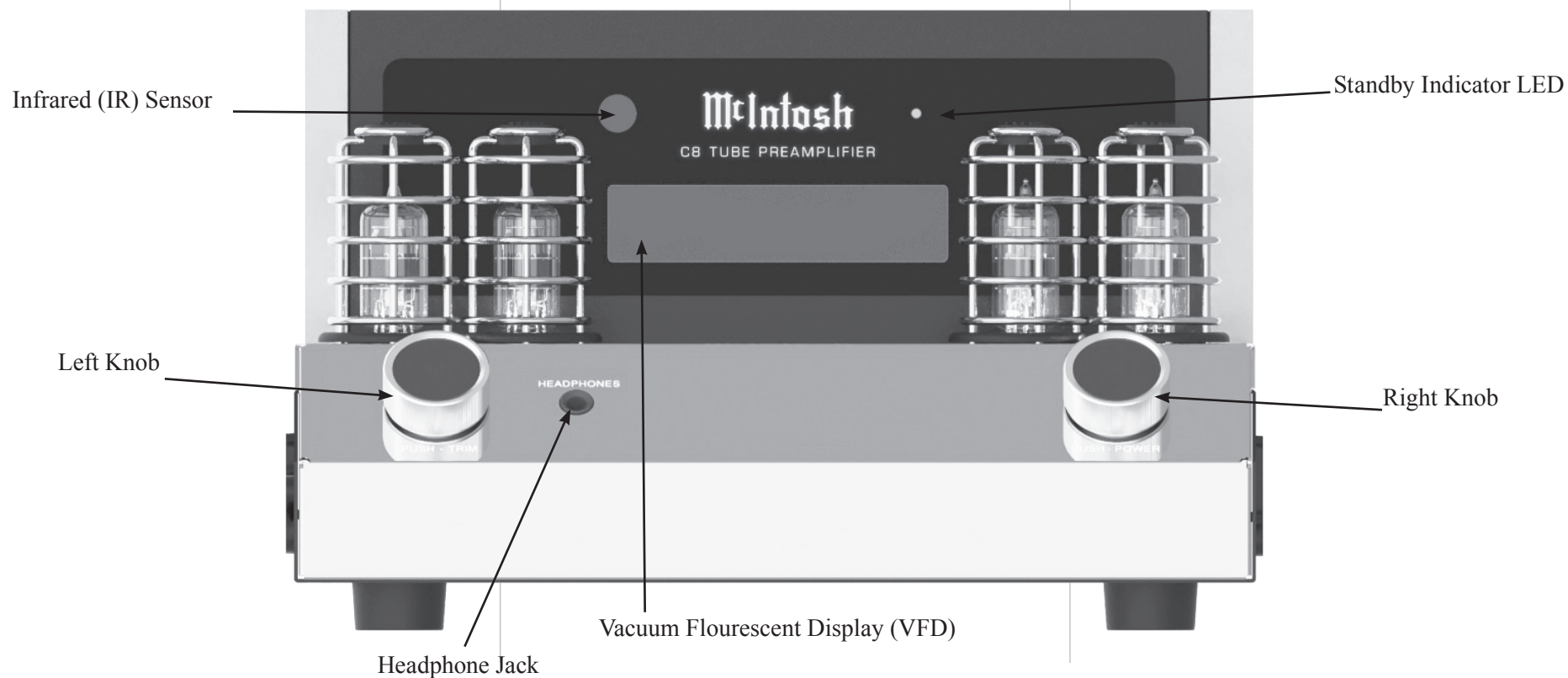

Figure 03– Front Panel

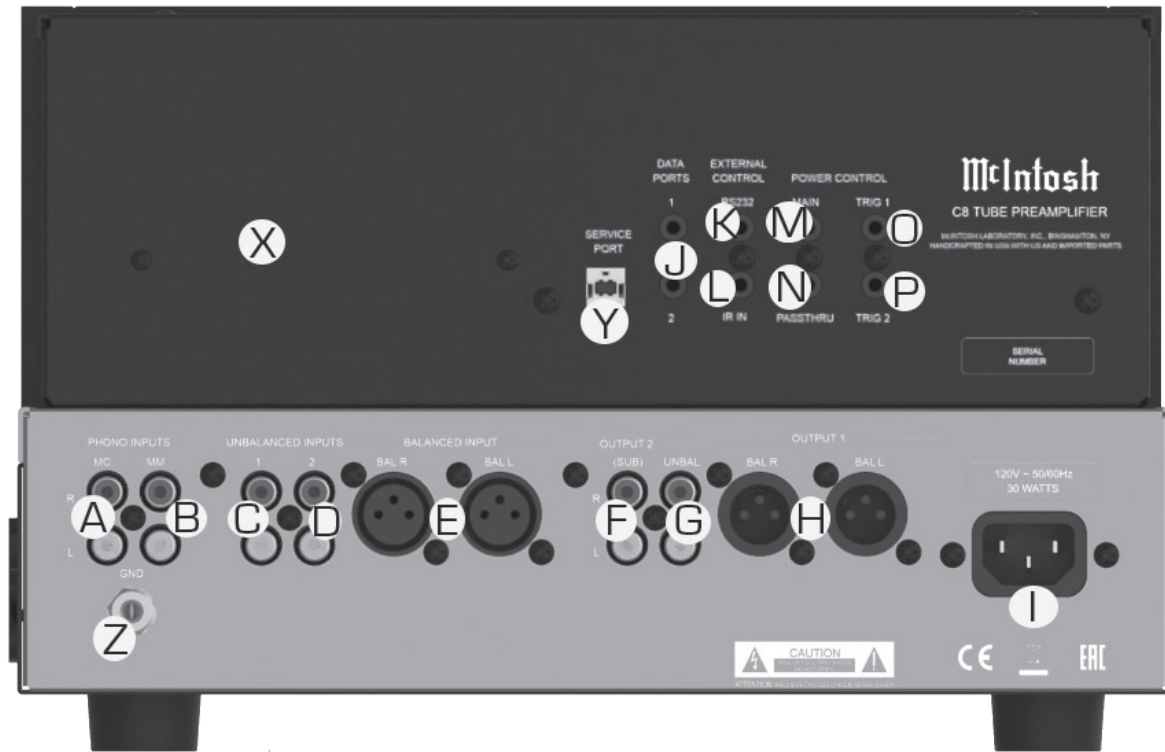

Figure 04– C8 Rear View

## Connections on the Back

### The Inputs

- One stereo pair of Moving Coil Phono inputs (A)
- One stereo pair of Moving Magnet Phono inputs (B)
- Two pair of stereo Unbalanced inputs- RCA Jacks (C) (D)
- One Stereo pair of Balanced inputs (E)
- One 1/8-inch jack for RS232 connector (K)
- One 1/8-inch jack for wired IR Input (L)
- One 1/8-inch PASSTHRU jack (N)
- One AC power connector (I)
- One USB upgrade service port (Y)

- One DA2 expansion slot (X)
- One Ground Connector (Z)

### The Outputs

- One Pair unbalanced RCA Output #1 (G)
- One pair balanced XLR audio Output #1 (H)
- One pair unbalanced RCA SUB/Output #2 (F)
- Two 1/8-inch Data Output jack (J)
- Three 1/8-inch jack Power Control (trigger) Outputs (M) (O) (P)

## Making Connections

### Phono/Unbalanced Inputs

Unbalanced Inputs such as the two PHONO INPUTS and UNBALANCED INPUTS 1 and 2 use RCA/phono cables to connect the C8 to other components. See “Figure 05– RCA/Phono Plugs” on page 9. Traditionally, the red connector is used to connect the right channel. You are free to break tradition but keep the channels straight or left and right might be reversed.





Figure 05– RCA/Phono Plugs

The C8 can accept the analog input from a wide variety on components such as CD players, tuners, and turntables. There are two sets of unbalanced inputs dedicated for turntable connections which allow customization of the input level. See Phono Adjustments on page 28.. The signal strength from phono cartridges vary and are lower than the line level received from most other components. The turntable will also have a ground connection which should be secured to the C8’s GND Binding Post to eliminate ground hum. Turn the Binding Post counterclockwise to loosen and attach the ground wire. Turn the Binding Post clockwise to secure the ground connection.

The MC PHONO INPUT should be used for low output Moving Coil Cartridges. The MM PHONO INPUT should be used for Moving Magnet and high output Moving Coil Cartridges.

## Balanced/XLR Input and Output

The BALANCED INPUT allows a source to be connected using XLR (balanced) cables if the source has this option.

XLR cables can also be used to connect the C8 to an amplifier. OUTPUT1 has a pair of XLR connectors

as well as a pair of RCA connectors. Both outputs can be used simultaneously if desired as in the case of bi-amping. To use the XLR output, connect the BAL R to the right input of your amplifier and BAL L to the amplifier’s left input.

Below is the Pin configuration for the XLR Balanced Input and Output Connectors on the C8. Refer to the diagrams for connections:

- PIN 1: Shield/Ground
- PIN 2: + Signal
- PIN 3: - Signal

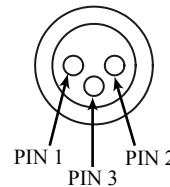

Figure 06– XLR pin diagram

## RS232

The RS232 jack is used to connect the C8 to automation controller devices with RS232 connectors. To utilize this feature, you will need an

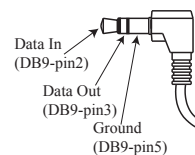

Figure 07– Mini plug for RS232 connection

appropriate RS232 Data Cable. The RS232 Data Cable should be an 1/8 inch (3.5mm) stereo mini phone plug to a subminiature DB9 connector.

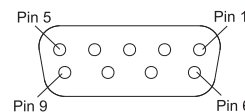

Figure 08– DB9 connector pin layout

## RS232 DB9 Connector Pin Layout

- |                        |        |
|------------------------|--------|
| 1. N/C (no connection) | 6. N/C |
| 2. Data In (RXD)       | 7. N/C |
| 3. Data Out (TXD)      | 8. N/C |
| 4. N/C                 | 9. N/C |
| 5. Gnd                 |        |

Typical RS232 settings are:

- 8 data bits, no parity and one stop bit
- Baud rate fixed at 115,200 bits per second

The baud rate can be changed in the Setup. See “RS232 Setup” on page 14.

## Wired IR Input

The IR Input allows an external IR receiver to be attached to the C8. The Input is labeled IR IN. By attaching an IR receiver using a 3.5mm cable (see Figure 09), the C8’s Remote Control can be used in another location without a line-of-sight to the C8’s front IR sensor.

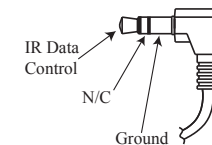

Figure 09– IR 3.5mm connector

If using an external IR receiver for the MAIN ZONE in the same room as the C8, you may wish to **disable the front IR sensor**. This will avoid potential timing issues of receiving the Remote Control’s commands from two different Inputs. The front IR can be turned on/off by doing the following:

- Press and Hold the Left Knob for two seconds
- Turn the Left Knob to the menu choice “SETUP: Front IR”

(Continued on page 11)



## Connection Diagram

There are many possible connections for the C8 depending on your system. This diagram shows a few typical ones.

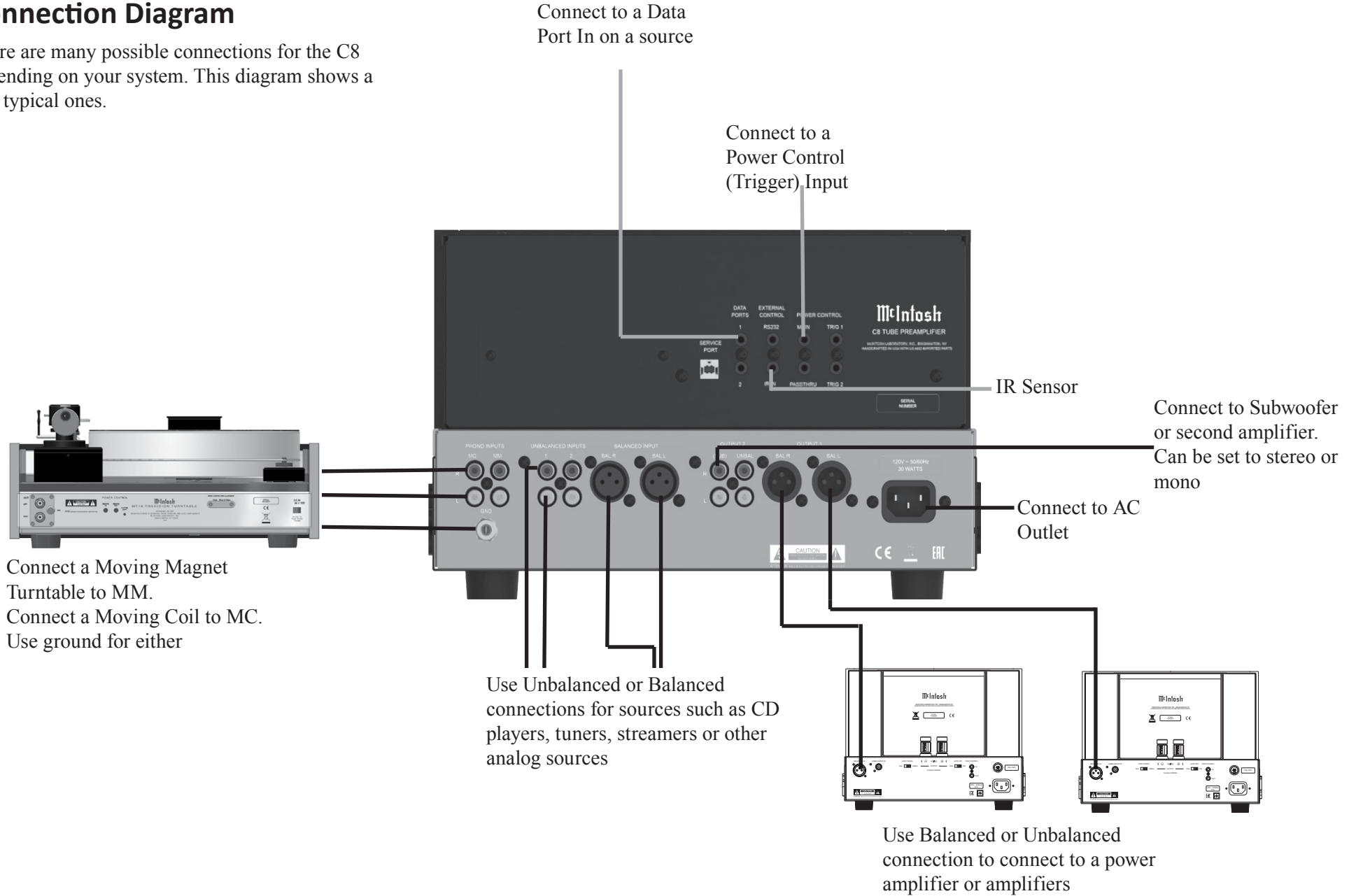

- Turn the Right Knob clockwise for Enabled (on) or counterclockwise (off)
- Press and release the Left Knob to exit the Setup menu

## DA2 Expansion Slot

The C8 has an expansion slot to allow for the installation of the DA2 Digital Audio Module. The DA2 will add the following digital audio inputs:

- two coax
- two optical
- one HDMI (ARC)
- one MCT
- one USB audio

Due to the technical nature of the DA2 upgrade, the upgrade **must be performed by a qualified trained professional at an Authorized McIntosh Dealer or Authorized McIntosh Service Agency**. Please note that if the upgrade is performed by anyone other than an Authorized McIntosh Dealer or Authorized McIntosh Service Agency, under the terms of your McIntosh Limited Warranty any resulting damage or failure of your unit will be excluded from warranty coverage. Contact your local Authorized McIntosh Dealer or Authorized McIntosh Service Agency to schedule your upgrade if you wish to add digital capabilities to your C8.

## AC Power

This connection is essential. Plug the female end of the supplied AC Power Cord into the AC connector (standard 15 ampere IEC) located in the rear right corner of the C8. Plug the male end of the AC Power Cord into a grounded and functioning AC outlet.

## Power Control (Trigger) Outputs

The C8 has three Power Control Outputs or Triggers:

- MAIN
- TRIG 1
- TRIG 2

Power Control enables power on/off signals to go to connected components so that other components can automatically powered on (or off) as called for by the C8.

Connect components to the Triggers using a 3.5mm stereo mini plug. see Figure 10. The Triggers work by sending on/off signals in the form of +12 volt/0 volt to connected McIntosh components.

“Trigger Setup” on page 13.

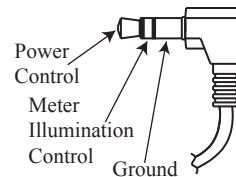

Figure 10– Power control (trigger) mini plug

## Passthru

The C8’s PASSTHRU feature allows your 2-channel system to be incorporated into a multichannel system, typically as the left and right front speakers. When the connected unit (Master) powers on, it will take control of your C8. The C8 will send the signal to your amplifier and speakers at a volume controlled by the Master. The C8 preamplifier is now a slave to the source unit and you cannot control the sound from this unit until the source unit is shutoff or disconnected.

To use the PASSTHRU feature, connect the controlling unit to the C8’s PASSTHRU connector using the same type of cable as used for Power

Control (Trigger) Outputs. The C8 PASSTHRU jack should be connected to a Power Control Trigger Output of the controlling unit.

To enable (or disable) PASSTHRU, enter Setup. When enabled, an Input must be assigned to PASSTHRU. When in PASSTHRU mode, the C8 will send the signal from the assigned Input to the C8’s Outputs. The volume will be dictated by the controlling unit.

To turn off or assign an Input for PASSTHRU:

- Press and Hold the Left Knob for two seconds
- Turn the Left Knob to the menu choice “SETUP: PASSTHRU”
- Turn the Right Knob to scroll through the following options:

- Off
- Balanced
- Unbal 1
- Unbal 2

(Note: if you have changed an Input’s name, the new name will appear.)

- Press and release the Left Knob to exit Setup. Your choice will be saved

When in PASSTHRU mode, control of the C8 is limited to the Trim functions: DISPLAY BRIGHTNESS and AMP METER LIGHT. To regain controls, the Controlling unit must be shut (or Power Control cable removed from the PASSTHRU connector.)

## Data Out

The C8 will convert IR Remote Control data to share with McIntosh components connected to the DATA PORTS. This will allow units that are out of range of an IR signal to receive commands. A McIntosh source can thereby be controlled by the C8 Remote.



There are two DATA PORTS labeled 1 and 2. To connect a McIntosh unit to a Data Port, use a 3.5mm stereo mini phone plug cable, see Figure 11.

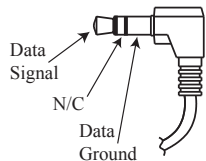

Figure 11– 3.5mm Data plug

## Headphones

The C8 features High Drive Headphone Amplification. The output of the High Drive Headphone Amplification provides plenty of power with the flexibility to utilize a wide range of headphones types including high impedance headphones.

Connect your headphones using a stereo ¼ inch plug to the HEADPHONES jack on the right of the INPUT Knob. The initial volume of the headphones will be the last volume used for headphones with a startup limit of 70. When headphones are connected, the other outputs are muted.

## USB Service Port

The USB port on the rear of the C8 is for McIntosh service use only. If you wish to add digital capabilities to your C8 see “DA2 Expansion Slot” on page 11.

## Power On the C8

To power on the C8, press and release the Right Knob. The C8 will go through a Tube Warmup stage. The Tubes will have an orange glow. When Tube Warmup is complete, the orange lights will turn green or off if the Tube Light Trim option is set to Off.

## Trim Functions and Settings

The Trim Functions allow you to make changes quickly to 11 different settings.

Trim Function	Settings
BALANCE	Adjust in degrees from right to left. Default is Centered
TONE CONTROL	On or Off (Default On)
BASS	-12 dB to +12 dB in 1 dB increments, Default is 0 dB
TREBLE	-12 dB to +12 dB in 1 dB increments, Default is 0 dB
MONO / STEREO	Mono or Stereo. Default is Stereo
OUTPUT 1	On or Off. Default is On
OUTPUT 2	On or Off. Default is On
INPUT TRIM	-6.0 dB to +6.0 dB in 0.5 dB increments
METER (AMP) LIGHTS	On or Off. Default is On
TUBE LIGHTS	On or Off. Default is On
DISPLAY BRIGHTNESS	Always On or Auto Off. Brightness adjustments: 25%, 50%, 75% or 100%

To use the Trim Menu you can either:

Press and release the Left Knob to enter the Trim Menu. Turn the Left Knob to scroll the Trim Functions. Turn the Right Knob to change settings for the current Trim Function. Press and release the Left Knob or allow the screen to time out to exit the Trim Menu, or turn the Left Knob to access a different Trim Function. The current setting will be saved.

Or:

With the C8’s Remote Control, press the SELECT / TRIM button to enter the Trim Menu. Use the up and down arrows (above and below the SELECT/TRIM button) to scroll the Trim Functions. Use the left and right arrows (left and right of the SELECT/TRIM button) to change and select settings. Press the SELECT/TRIM button to leave the Trim Menu or use the up and down arrows to select other Trim Functions. The Trim Menu will automatically exit after 10 seconds of no activity. Current settings will be saved.

## Phono Trim Function

When either of the Phono Inputs is selected, a Phono Trim Function becomes available in the Trim Menu.

For MM Phono Input, the Trim Function is called PHONO CAPACITANCE. This setting allows you to choose a setting that most closely matches the recommended setting for your Moving Magnet Phono cartridge. The options are selected by rotating the Right Knob. The options range from 50pF to 400pF in 50pF increments.

For MC Phono Input, the Trim Function is called PHONO RESISTANCE. This setting allows you to choose a setting that most closely matches the recommended setting for your Moving Ceramic Phono cartridge. The options are selected by rotating the Right Knob. The options are: 50, 100, 200, 400 and 1000 ohms.

## Tone Control, Bass and Treble

Bass and Treble can only be adjusted when TONE CONTROL is set to On. When TONE CONTROL is off, Bass and Treble will be 0 dB. When Tone Control is On, previous Bass and Treble settings will be active, and can be changed. Tone changes

are saved uniquely for each input and are not universal.

## Output 2

Outputs 1 and 2 can be toggled On and Off through the Trim settings. Output 2 is also called a SUB out and may be connected to a Subwoofer. Output 2 is full range and stereo and can be attached to another amplifier perhaps in another zone (room). Using this Trim Function is an easy way to toggle this zone On and Off.

## Meter (Amp) Lights

This setting controls the status of meter lights of a McIntosh amplifier controlled through a connected Power Control (Trigger) cable (see “Power Control (Trigger) Outputs” on page 11).

## Display Brightness

Display Brightness can be set to Always On and Auto Off. Turn the Right Knob clockwise or use the Right Arrow on the Remote Control to select Always on. Continuing to turn the knob or pushing the Right Arrow will cycle through four brightness settings: 25%, 50%, 75% and 100%.

Turning the Right Knob counterclockwise or pushing the Left Arrow on the Remote Control will select Auto Off. Continuing to turn the knob or pushing the Left Arrow will cycle through four brightness settings: 25%, 50%, 75% and 100%.

When set to Auto Off, the C8’s display will blackout when no input is received for 10 seconds. Turning the Left Knob or pushing it twice will awaken the display.

## Setup Settings

To enter the C8’s Setup menu, press and hold the Left Knob for 2 seconds. The VFD (display) will change. Rotate the Left Knob to scroll through the available screens. Push and release the Left Knob to exit a menu.

### Firmware and Serial Number

This screen display the current firmware version as well as your unit’s serial number.

### Input Setup

To edit Input information, press and hold (two seconds) the Left Knob at the Setup: Inputs menu (see Figure 12 ).

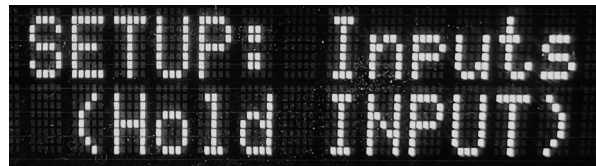

Figure 12– Inputs Menu

Rotate the Left Knob to view the Inputs

- Balanced
- Unbal 1
- Unbal 2
- MM Phono
- MC Phono

(If DA2 Expansion (see “DA2 Expansion Slot” on page 11) has been added, additional Inputs will appear).

The selected input can be turned On (default) or Off by turning the Right Knob. If On is selected, the Input can be renamed. To rename the selected input, press and hold the Left knob until the RENAME

screen appears. Turn the left knob to select the character to change and the right knob to select characters. When your changes are complete, press and hold the Left Knob for two seconds to save. You will return to the previous screen with the new name visible.

An Input that has been turned Off will not appear as an available Input when scrolling. To make it visible again, set the Input to On.

## Output 2 (SUB)

Output 2 also know as SUB Output can be set to Stereo (default) or Mono. Output is full range and stereo so if using only one channel (left or right) of the output, Output 2 should be set to Mono. Turn the Right Knob to change selections.

## Trigger Setup

The C8 has three Power Control Outputs or Triggers. The Main Trigger sends power commands to attached components based on the overall power status of the C8 (On or Off). Trigger 1 and Trigger 2 can be set to act like the Main Trigger or be assigned to follow Output 1 or 2 or any Input’s status.

The default of Trigger 1 and Trigger 2 is Main. To change the setting for Trigger 1 or 2:

- Scroll to “Setup: Triggers” in the Setup Menu
- Press and hold the Left Knob for two seconds
- Turn the Left Knob to select Trigger 1 or Trigger 2 to edit
- Turn the Right Knob to select Main, Output 1, Output 2 or Input
- To choose an Input, press and hold the Left Knob for two seconds. Turn the Left Knob to scroll through the Inputs. Turn the Right Knob to select On or Off. Selecting On will send a



power command from that Trigger when that Input is selected on the C8. Multiple Inputs can be set as Triggers

- Press the Left Knob to exit the menu. Changes will be saved

## Data Port Setup

Data Port connections allow the Remote Control commands sent to the C8 to be sent to components attached via the Data Ports. Data Port Setup defines when to send that data based on the selected Input. The default is “All Data” which will send data to connected components whenever data is received.

The options for when to send data are:

- All Data
- Balanced
- Unbal 1
- Unbal 2

To assign an input to Data Port 1 or Data Port 2:

- Scroll to “Setup: Data Ports” in the Setup Menu
- Press and hold the Left Knob for two seconds
- Turn the Left Knob to select Data Port 1 or Data Port 2 to edit
- Turn the Right Knob to select the Input you wish to work with that Data Port
- Press the Left Knob to exit the menu. Changes will be saved

## Passthru

Using the Passthru feature on your McIntosh Preamplifier allows your 2-channel system to be incorporated into a multichannel system, typically as the left and right front speakers. When the source unit powers on, it will take control of your preamplifier. The preamplifier will send the signal to your amplifier and speakers at a volume controlled

by the source. In this case the source is a home theater unit, preamp/processor or receiver. Your preamplifier is now a slave to the source unit and you cannot control the sound from this unit until the source unit is shutoff or disconnected.

To Set Up a Passthru relationship:

- Connect the Power Control output of the unit you wish to use as the Source to the Passthru input on your preamplifier.
- Scroll to “Setup: PASSTHRU” in the Setup Menu
- Turn the Right Knob to select the Input to be used by Passthru. The default is off. Other choices are Balanced, Unbal 1 and Unbal 2. Digital inputs (if added) and Phone inputs are not available as input choices for Passthru. Typically, you should choose the input that the Master is connected to

Now when the source unit is powered on, a signal will be sent to your preamplifier and the connected input will play. That input will not be available to play outside of the master/slave relationship unless you change the setup.

For more information see “Passthru” on page 11.

## RS232 Setup

The Setup menu for RS232 allows you to change the default Baud rate setting of 115,200 to any of the following: 9600, 19200, 38400, 57600. To change the Baud rate:

- Scroll to “Setup: RS232” in the Setup Menu
- Turn the Right Knob to select the desired Baud rate
- Press the Left Knob to exit the menu. Changes will be saved

For more information see “RS232” on page 9.

## IR Codes Setup

The C8 can be controlled by a Remote Control using Alternate Codes. The option to use Alternate Codes is provided to avoid the conflict of with another McIntosh Preamplifier or Processor that may be in the same location. To set the C8 to respond to Alternate Codes:

- Scroll to “Setup: IR Codes” in the Setup Menu
- Turn the Right Knob to choose either Normal (default) or Alternate

To use Alternate Codes with the C8 requires an optional McIntosh Remote Control such as the HR085 which can be set to utilize these codes.

## Front IR Setup

If using an external IR receiver for the MAIN ZONE in the same room as the C8, you may wish to **disable the front IR sensor**. This will avoid potential timing issues of receiving the Remote Control’s commands from two different Inputs. The front IR can be turned on/off by doing the following:

- If not already in Setup, press and hold the Left Knob for two seconds
- Turn Knob to the menu choice “SETUP: Front IR”
- Turn the Right Knob clockwise for Enabled (on) or counterclockwise for Disable(off)
- Press and release the Left Knob to exit the Setup menu

This information and more can be found in “Wired IR Input” on page 9.

---

## Auto-Off Setup

When Enabled, the Auto-Off feature automatically powers off the C8. This occurs approximately 30 minutes after there has been an absence of user activity (includes changes to any of the Operation Functions such as source selection, volume adjustment, etc.) or absence of an audio signal.

To Enable (default) or Disable the Auto-Off feature:

- Turn Knob to the menu choice “SETUP: Auto-Off”
- Turn the Right Knob clockwise for Enabled (on) or counterclockwise Disable (off)
- Press and release the Left Knob to exit the Setup menu

## FACTORY RESET

Use the FACTORY RESET option if you wish to return all settings to factory defaults. All changes made will be lost such as renamed Inputs or Trigger assignments..

- Turn Knob to the menu choice “SETUP: FACTORY RESET”
- Press and hold the Left Knob for two seconds until the display reads “In Progress”
- The C8 will power off when the Factory Reset is complete



## Remote Control Buttons

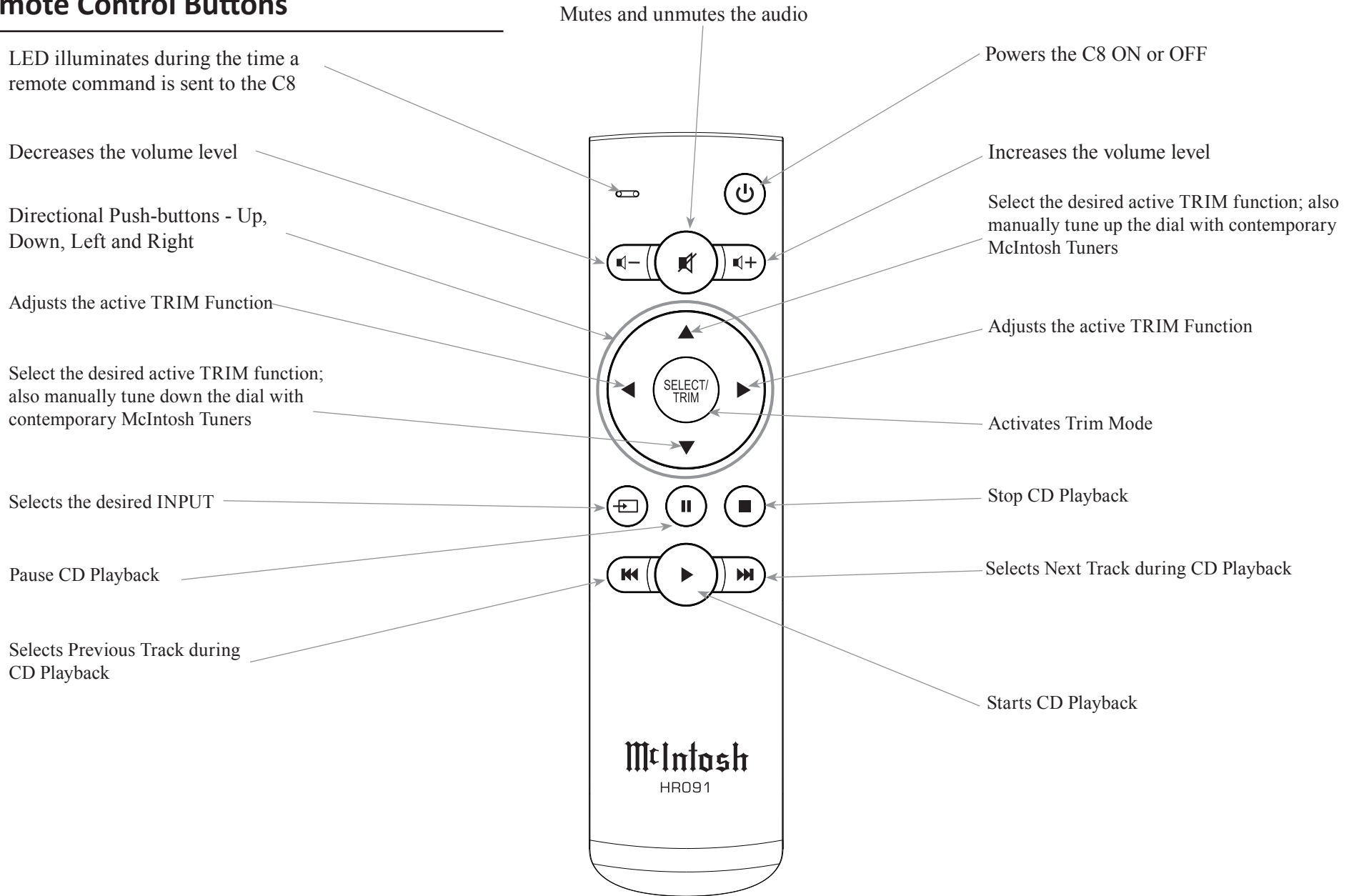





The supplied Remote Control performs the various Operating Functions for the C8 Preamplifier.

### Input Source Selection

Press the Push-button → to select the desired program source.

### Volume

Press the + or - Push-buttons to increase or decrease the listening level.

### Mute

Press the  (Mute) Push-button to mute the audio and a second time to resume listening.

### Select Push-Button

Press the SELECT/TRIM Push-button to activate the Trim Mode. Then use the Directional Push-Buttons to select a Trim Mode Function and make changes.

### Directional Push-Buttons

After having pressed the SELECT Push-button, press the ▲ ▼ (Up or Down) Push-buttons to scroll through the various Trim Functions. Then press the ◀ ▶ (Left or Right) Push-buttons to make a change to the current Trim Setting.

## Changing the Remote's Battery

Someday, the AAA battery in the remote will need to be replaced. This is how to do it.

The back of the remote control is held in place by magnets. To remove the back of the remote to reveal the battery, slide the front of the remote up while sliding the back of the remote down. The goal is to move the back 3/16 of an inch from the top of the remote and then lift it off. There are many ways to do this, as far as positioning your fingers. To open the remote:

- Hold the remote upsidedown and backwards with McIntosh name upsidedown and facing away from you. The thicker end will now be the top and you should be staring at the back of the remote.
- Pinch the remote with your index finger resting on the SELECT/TRIM button and your thumb on the backside (facing you) opposite your index finger's position. Your thumb and remote should both be pointing away from you (*see Figure 13*).
- Use your thumb to slide the back open 3/16 of an inch. Slide your thumb away from you towards the thicker end of the remote, while your index finger goes in the opposite direction (towards you). As if snapping your fingers in slow motion. For added strength, you can use your other hand in a similar position above your first hand using the same technique. Make sure you do not hold the side edge with either hand.
- Lift the back off with your other hand before it snaps closed again. You can grab the now exposed top edge.
- It gets easier after the first time.

Remove and replace the battery noting the polarity (printed below the battery if you forget).

To replace the back: Place the back in position 3/16 of an inch from the edge. The magnets will help you snap it back into place.

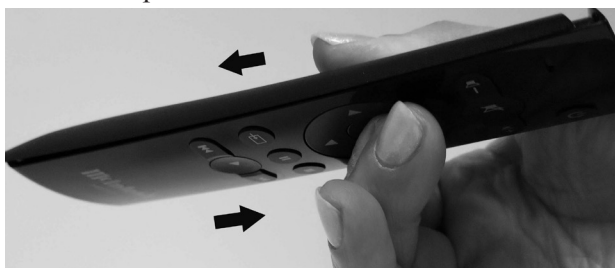

Figure 13– Opening the Remote Control



## Packing the C8

When shipping the C8, it is highly recommended that the unit be packed as it was originally shipped to avoid damage. Failure to properly pack the unit will likely result in damage. (The front panel is made of glass!) If you need any of the packing material, you can contact McIntosh Customer Service. Use only packing material that is in good condition and replace any material that has seen better days.

It is very important that the four plastic feet are properly placed in the holes of the Foam Bottom Pad. This will ensure the proper equipment location for shipping. Failure to do this will result in shipping damage.

Quantity	Part Number	Description
1	034661	Shipping Carton
1	034654	Foam Pad Bottom
1	034658	Foam Top Cover
1	033656	Foam Ring
1	033657	Foam Upper Ring
1	034579	Foam Tube Cage
1	034655	Foam Top
1	034662	Sheet Slit Scored

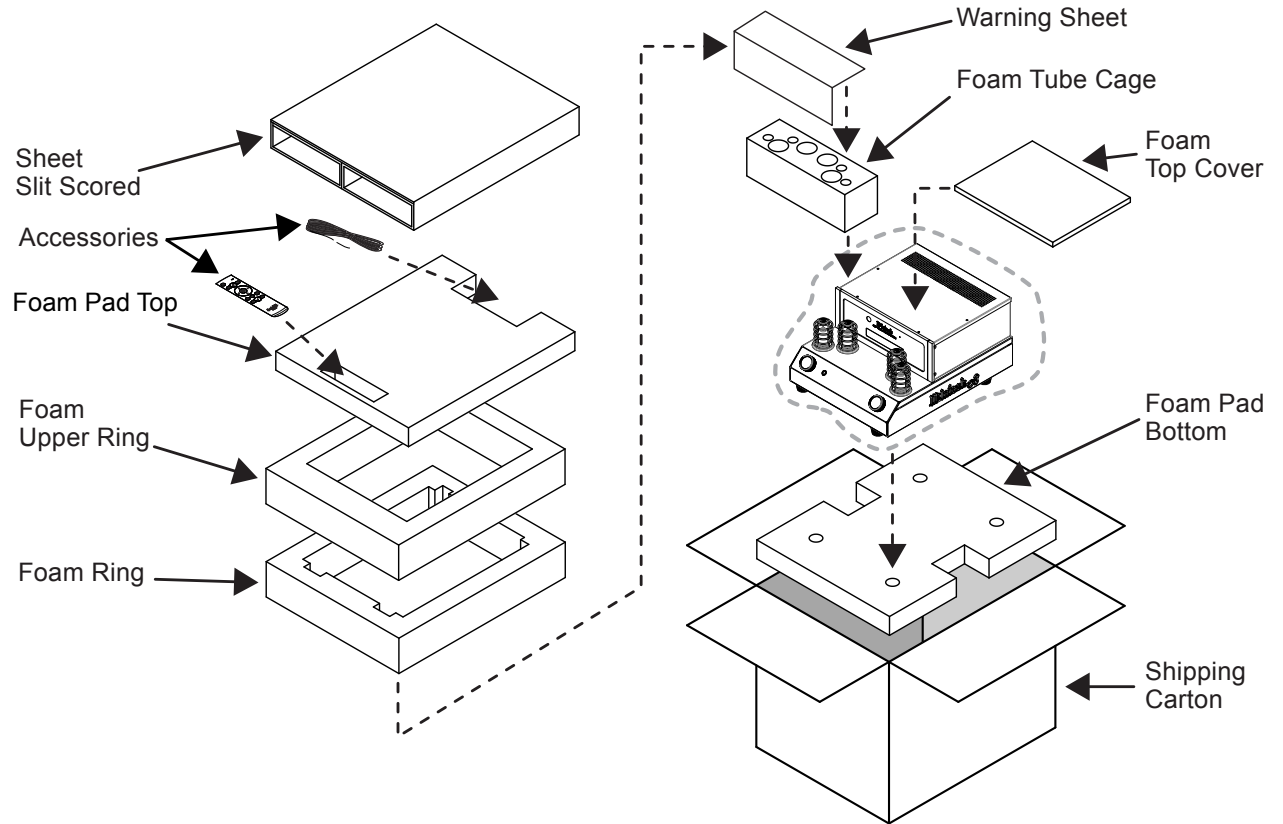

Figure 14- Re-packing diagram

---

## Specifications

---

### Frequency Response

+0, ±0.5dB from 20Hz-20,000Hz

+0, -3dB from 15Hz-100,000Hz

### Total Harmonic Distortion

0.08% maximum from 20Hz to 20,000Hz at rated Output

### Signal To Noise Ratio (A-Weighted)

High Level: 95dB (below rated Output)

Phono MM: 80dB (below 5mV input)

Phono MC: 75dB (below 0.5mV input)

### Maximum Output Voltage

8V RMS Unbalanced

16V RMS Balanced

### Rated Output

2.5V Unbalanced

5V Balanced

### Output Impedance

100 ohms Unbalanced

200 ohms Balanced

### Input Impedance

High Level - 22K ohms Unbalanced

44k ohms Balanced

Phono MM - 50 to 400pF, in 50pF steps;

47K ohms

Phono MC - 50, 100, 200, 400 or 1,000 ohms;

100pF

### Headphone Load Impedance

100 ohms to 600 ohms

### Sensitivity (for rated output)

High Level, 450mV Unbalanced, 900mV Balanced

Phono MM, 4.5mV

Phono MC, 0.45mV

### Maximum Input Signal

High Level, 5V Unbalanced, 10V Balanced

Phono MM, 80mV

Phono MC, 8mV

### Voltage Gain

High Level to Output 1 or 2: 15dB

Phono MM to Output 1 or 2: 55dB

Phono MC to Output 1 or 2: 75dB

### Power Control and Trigger Output

12VDC, 25mA

### Power Requirements

*Field AC Voltage conversion of the C8 is not possible. The C8 is factory conFigured for one of the following AC Voltages:*

100 Volts, 50/60Hz at 50 watts

110 Volts, 50/60Hz at 50 watts

120 Volts, 50/60Hz at 50 watts

220 Volts, 50/60Hz at 50 watts

230 Volts, 50/60Hz at 50 watts

240 Volts, 50/60Hz at 50 watts

Standby, less than 0.5 watt

*Note: Refer to the rear panel of the C8 for the correct voltage.*

### Overall Dimensions

Width is 12-9/32 inches (31.2cm)

Height is 7-5/8 inches (19.4cm) including feet

Depth is 16-1/4 inches (41.3cm) including the Front Panel, Knobs and Cables

### Weight

18 pounds (8.2Kg) net, 25 pounds (11.3Kg) in shipping carton

### Shipping Carton Dimensions

Width is 20-3/8 inches (51.8cm)

Height is 13-1/4 inches (33.7cm)

Depth is 16-1/4 inches (41.3cm)



The continuous improvement of its products is the policy of McIntosh Laboratory Incorporated who reserve the right to improve design without notice.

Printed in the U.S.A.

McIntosh Part No. 24109701