



McIntosh Laboratory, Inc. 2 Chambers Street Binghamton, New York 13903-2699 Phone: 607-723-3512 [www.mcintoshlabs.com](http://www.mcintoshlabs.com)

# MC3500

Mono Tube Amplifier

Owner's Manual





**Important Safety Information is supplied in a separate document “Important Additional Operation Information Guide”**

---

**Thank You**

---

Your decision to own this McIntosh MC3500 Tube Power Amplifier ranks you at the very top among discriminating music listeners. You now have “The Best.” The McIntosh dedication to quality is assurance that you will receive many years of musical enjoyment from this unit.

Please take a short time to read the information in this manual. We want you to be as familiar as possible with all the features and functions of your new McIntosh.

---

**Please Take A Moment**

---

The serial number, purchase date, and McIntosh Dealer name are important to you for possible insurance claims or future service. The spaces below have been provided for you to record that information:

Serial Number: \_\_\_\_\_

Purchase Date: \_\_\_\_\_

Dealer Name: \_\_\_\_\_

---

**Technical Assistance**

---

If at any time you have questions about your McIntosh product, contact your McIntosh Dealer who is familiar with your McIntosh equipment and any other brands that may be part of your system. If you or your Dealer need additional help concerning a suspected problem, you can receive technical assistance for all McIntosh products at:

McIntosh Laboratory, Inc.  
2 Chambers Street  
Binghamton, New York 13903  
Phone: 607-723-3512  
Fax: 607-724-0549

---

**Customer Service**

---

If it is determined that your McIntosh product is in need of repair, you can return it to your Dealer. You can also return it to the McIntosh Laboratory Service Department. For assistance on the factory repair return procedure, contact the McIntosh Service Department at:

McIntosh Laboratory, Inc.  
2 Chambers Street  
Binghamton, New York 13903  
Phone: 607-723-3515  
Fax: 607-723-1917

---

**Table of Contents**

---

Unpacking the MC3500 ..... 4  
General Information ..... 6  
Connector and Cable Information ..... 6  
Introduction..... 6  
Performance Features ..... 6  
Dimensions ..... 7  
Navigating the Rear Panel ..... 8  
Connection Diagram..... 9  
How to Connect Loudspeakers..... 10  
Navigating the Front Panel..... 12  
How to Operate..... 12  
Amplifier Specifications..... 14  
General Specifications..... 14  
Packing Instructions ..... 15

---

# **IMPORTANT!**

**INSTRUCTIONS FOR REMOVAL  
OF FOAM INSERT OVER THE  
VACUUM TUBES PRIOR TO  
CONNECTING THE A.C. POWER  
SUPPLY CORD START ON THE  
NEXT PAGE.**





## Unpacking the MC3500

**WARNING:** To prevent damage to the MC3500 Vacuum Tubes during shipping, there is a special foam insert surrounding the Vacuum Tubes of the Power Amplifier.

*The Foam Insert must be removed from the MC3500 before connecting the AC Power Supply Cord to the Power Amplifier.*

*Failure to do so is a Fire Hazard, which could result in damage to the MC3500 and the surrounding environment.*

*Follow these instructions for removal of the packing foam before connecting the AC Power Supply Cord to the MC3500.*

In order to remove the foam insert surrounding the Vacuum Tubes on the MC3500, it is necessary to temporarily remove the Tube Cover. After the foam insert is removed, the Tube Cover must be reinstalled for proper and safe operation of the MC3500 Power Amplifier. The Tube Cover provides protection from the hazardous voltages inside the MC3500. The MC3500 has no user serviceable parts, including the Vacuum Tubes. If repairs are needed, they must be performed by an authorized McIntosh Service Agency.

1. Orient the MC3500 so the rear of the Power Amplifier is facing you and remove the Warning Sheet. Refer to figure 1.
2. Remove the four screws and the two Hot Surface Tags located on the top of the Tube Cover by using a #2 Phillips Head Screw Driver. Refer to figure 1.
3. Place the Tube Cover, Hot Surface Tags, and screws in a safe location, as the Tube Cover will be reinstalled.

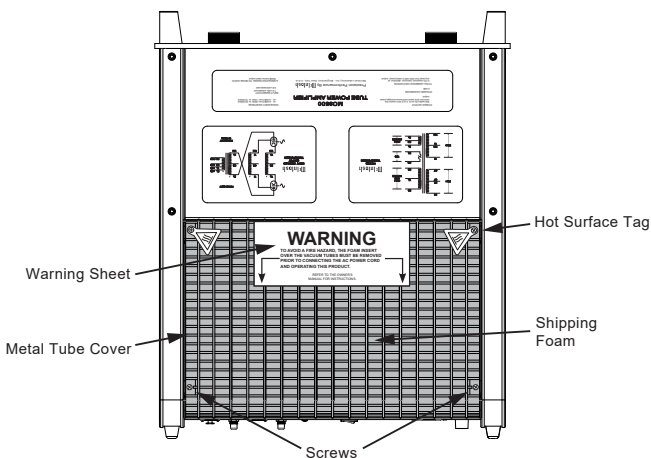

Figure 1

4. Carefully lift up and remove the Tube Cover from the MC3500. Refer to figure 2.
  5. Carefully lift up and remove the Foam Insert from the MC3500, exposing the Vacuum Tubes. Refer to figures 3 and 4.
  6. Carefully place the Tube Cover back on the MC3500.
  7. Place the Hot Surface Tags in the top corners of the Tube Cover. Secure the Cover to the MC3500 Chassis using the four screws. Refer to figure 5.
- Note: Save the Foam Insert and Warning Sheet with the MC3500 Shipping Carton for future use.*

Figure 2

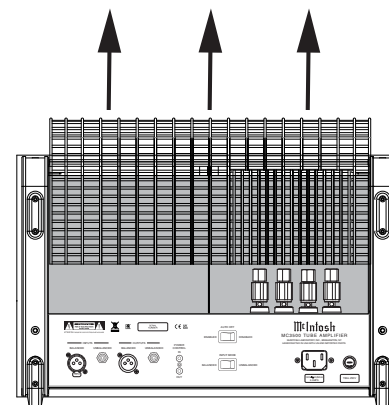

Figure 3

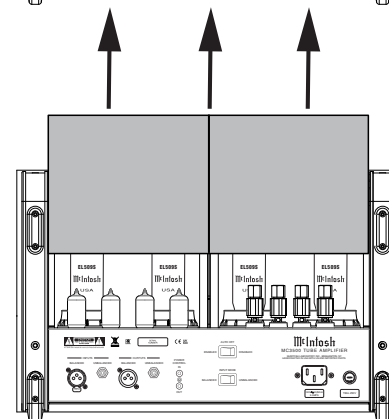
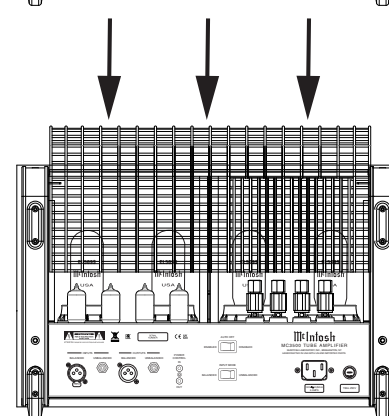

Figure 4



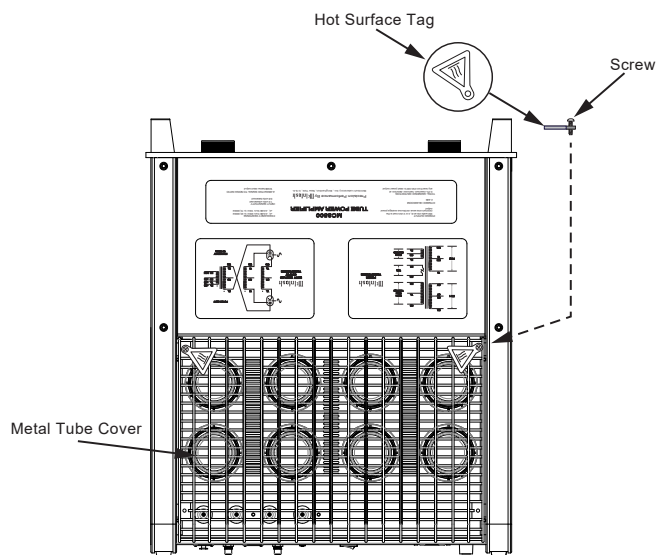

Figure 5

### Ventilation

Adequate ventilation extends the trouble-free life of the MC3500. Always allow air to flow through the ventilation holes on the bottom of the amplifier and a means for the warm air to escape at the top. Refer to figure 6.

Allow at least 19 inches (48.3cm) above the top; 6 inches (15.2cm) for the Front, Rear and Sides; allow 7/8 inch (2.2cm) below the Power Amplifier so airflow is not obstructed.

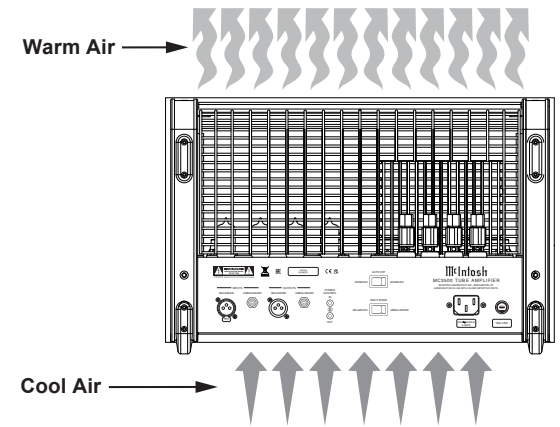

Figure 6

## General Information

1. For additional connection information, refer to the documentation included with any component(s) connected to the MC3500.
2. Apply AC Power to the MC3500 and other components only after all the system components are connected together. Failure to do so may cause a malfunction of system operations as the Microprocessor's Circuitry inside the components is active when AC Power is applied.
3. When discarding the unit, comply with local rules or regulations. Batteries should never be thrown away or incinerated but disposed of in accordance with the local regulations concerning battery disposal.
4. For additional information on the MC3500 and other McIntosh Products, please visit the McIntosh Website at [www.mcintoshlabs.com](http://www.mcintoshlabs.com).

## Connector and Cable Information

### XLR Connectors

Below is the Pin configuration for the XLR Balanced Input Connectors on the MC3500. Refer to the diagram for connection:

- PIN 1: Shield/Ground
- PIN 2: + Output
- PIN 3: - Output

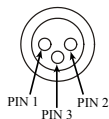

### Power Control Connector

The Power Control Input Jack receives Power On/Off Signals when a component is connected. The Power Control Output will in turn provide a +12 volt Output Signal with a current up to 25 mA. An additional connection is for controlling the illumination of the MC3500 Power Meter when connected to a compatible

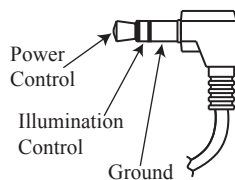

McIntosh Preamplifier or A/V Control Center Power Control Output. A 3.5mm stereo mini phone plug is used for these connections.

### Output Terminal Connector

When cables with spade lugs are used for Loudspeaker Connection, the spade lugs need an opening of at least 3/10 inch (7.6mm)

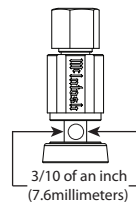

## Introduction

Now you can take advantage of traditional McIntosh standards of excellence in the MC3500 Tube Power Amplifier. The 350 watt power output will drive any high quality Loudspeaker System. The MC3500 reproduction is sonically transparent and absolutely accurate. The McIntosh Sound is "The Sound of the Music Itself."

## Performance Features

### Power Output

The MC3500 is a Tube Power Amplifier with a capability of 350 watts into 2-, 4-, or 8-ohm Loudspeakers with less than 0.3% distortion.

### Unity Coupled Circuitry

The MC3500 Power Amplifier uses the famous McIntosh Patented Unity Coupled Circuit which provides low distortion, extended frequency response and cool operating output tubes.

### Multifilar Wound Output Transformer

The MC3500 Output Transformer Windings are part of the Unity Coupled Circuitry. There are three trifilar wound primaries, one for the cathodes, one for the plates, and one for the screens. The secondary winding is wound together with the primary windings. This provides very close primary to secondary coupling. The result is flat frequency response and wide power bandwidth.

### Balanced and Unbalanced Input

Balanced connections guard against induced noise and allow long cable runs without compromising sound quality.

### Sentry Monitor Tube Protection

Sentry Monitor provides protection for the MC3500 by monitoring Output. In the event of a large impedance mismatch, a short circuit at the Output Terminals, or Tube failure, Sentry Monitor will activate to prevent potentially destructive levels of current from flowing.

### Vacuum Tube Sockets

Small Signal Vacuum Tubes Sockets have Ceramic Base construction with gold plated contacts, providing protection from atmospheric contamination. Output Tube Sockets include Air-Pipe cooling at their bases for long term operation.

### Amplifier Gold Plated Connectors

Gold Plated Input Jacks and Output Binding Posts provide trouble free connections.

### Special Power Supply

A very large core Power Transformer and large filter capacitors ensure stable operation.

### Power Guard Screen Grid Sensor (SGS)

Power Guard Screen Grid Sensor™ (SGS) helps prevent premature Vacuum Tube failure by monitoring the screen grid current in the EL509S output Vacuum Tubes. If the current becomes too high, a circuit in Power Guard SGS™ is activated which then dynamically attenuates the input signal in real time to keep the Vacuum Tubes operating at safe levels. The right amber LED will flash when Power Guard SGS is engaged in protecting the Vacuum Tubes.

# Dimensions

Front View

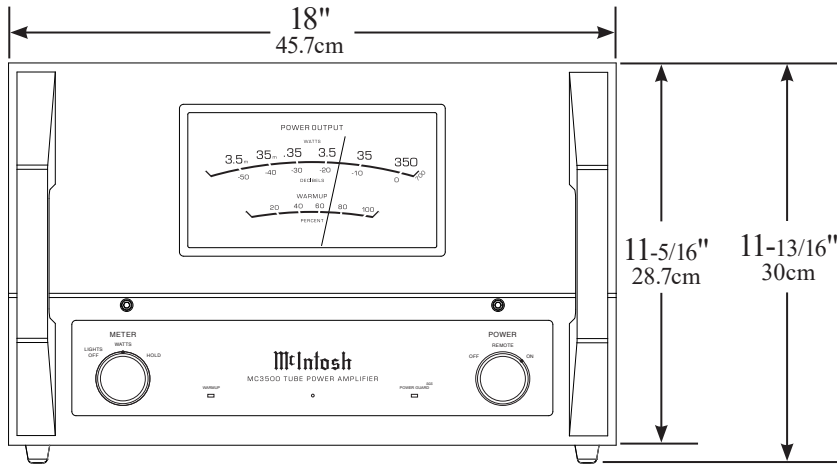

Side View

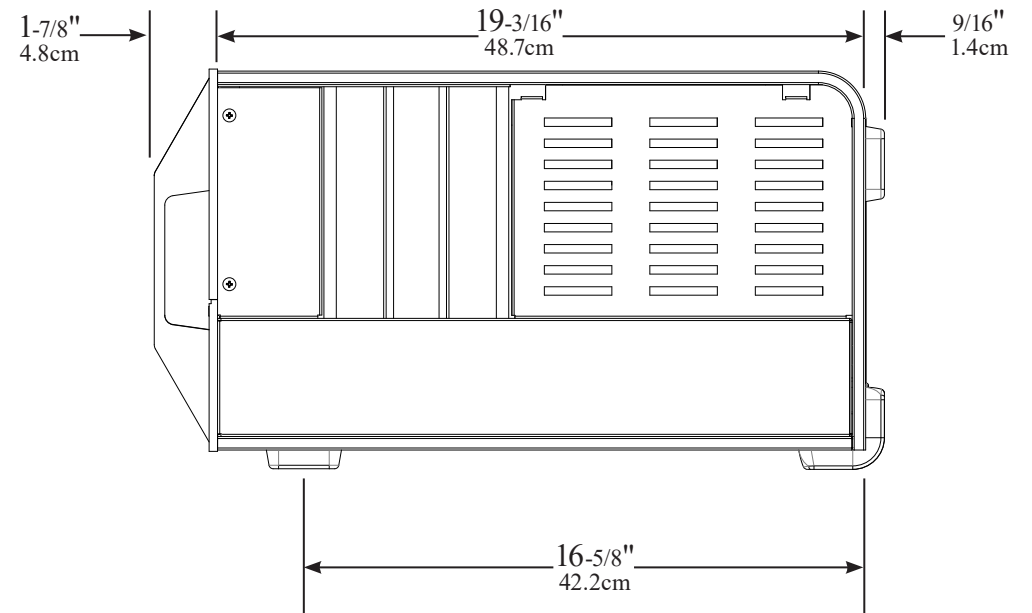

Rear View

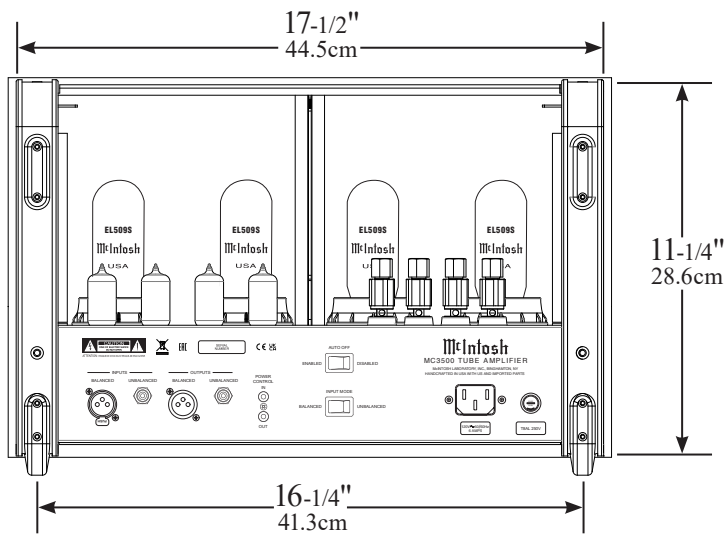



## Navigating the Rear Panel

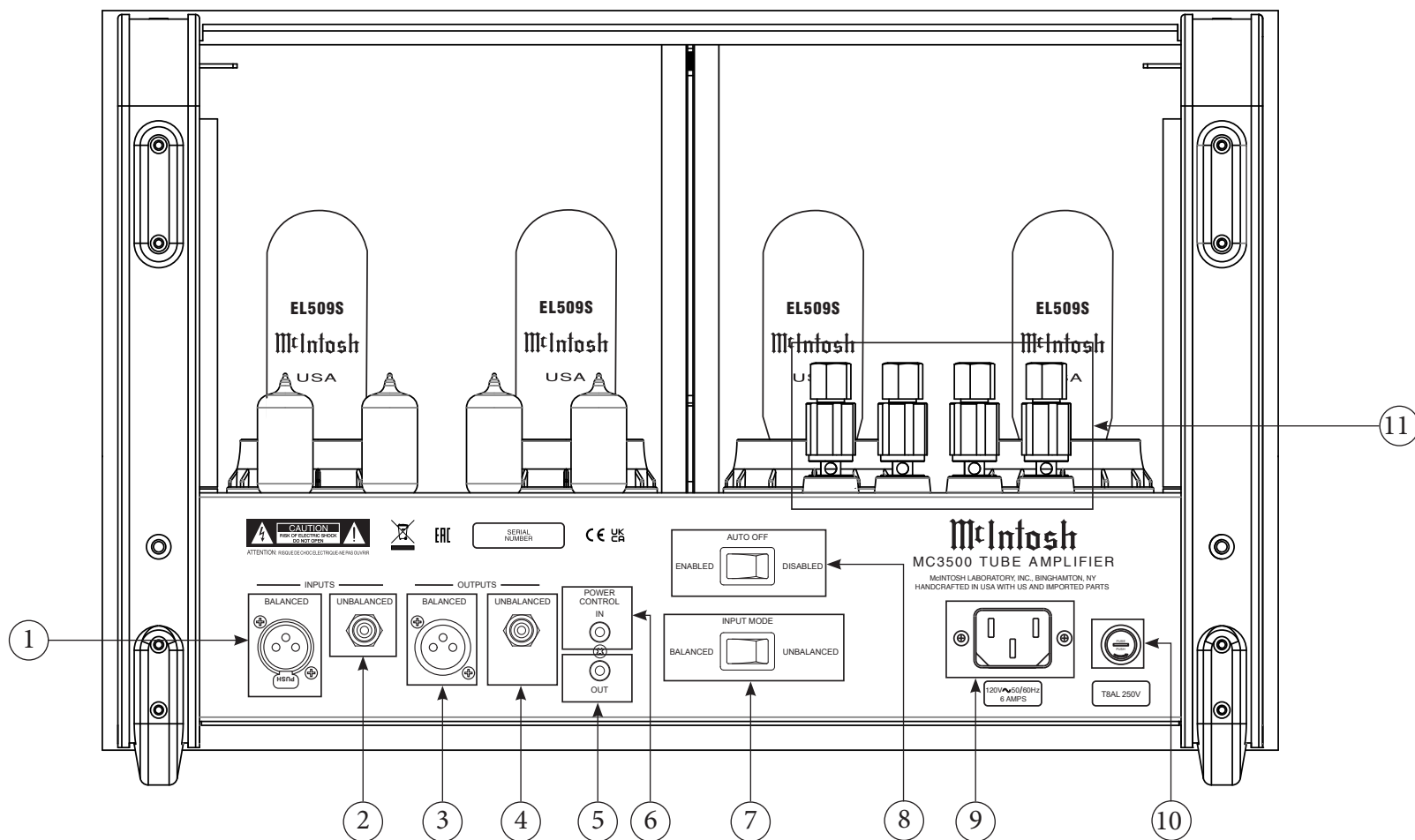

**1. Balanced Input:** Connect an XLR connector cable (see Page 6) from an external output device into this port to amplify a Balanced signal.

**2. Unbalanced Input:** Connect an RCA connector cable from an external output device into this port to amplify an Unbalanced signal.

**3. Balanced Output:** This port produces a signal from the Balanced Input using an XLR connector cable (see Page 6)

**4. Unbalanced Output:** This port produces a signal from the Unbalanced Input using an RCA connector cable.

**5. Power Control Out:** Sends an On/Off signal to a connected McIntosh component via a 3.5mm cable (see Page 6).

**6. Power Control In:** Receives an On/Off signal from a connected McIntosh component via a 3.5mm cable (see Page 6).

**7. Input Mode Switch:** Switch to toggle between Balanced and Unbalanced Inputs.

**8. Auto Off:** Switch to Enable/Disable Auto Off function.

**9. Main Power:** Connect to a power outlet using the included power cable to supply power to the MC3500.





**10. Fuse Holder:** Houses the fuse to power the unit.

**11. Loudspeaker Terminal Posts:** Connect loudspeakers using speaker cable (see Page 10).



# Connection Diagram

## Connection Legend:

- AC Power Cable: 
- Loudspeaker Cable: 
- Power Control Cable: 
- Audio Signal Cable: 

Loudspeaker

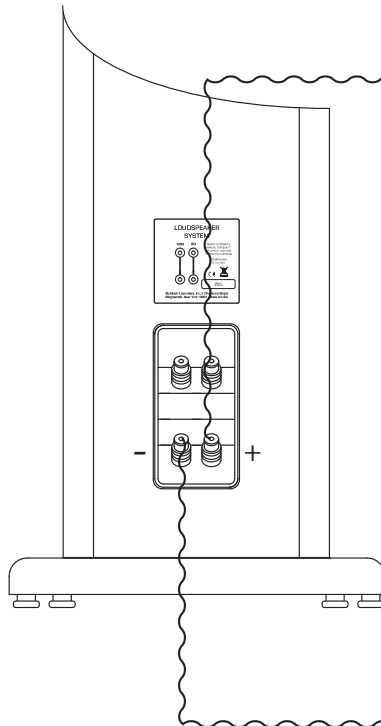

Preamplifier

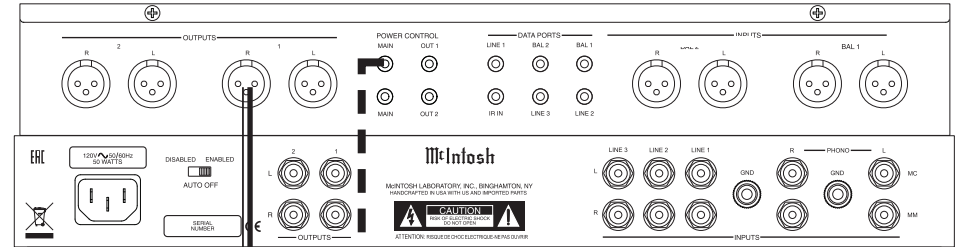

MC3500

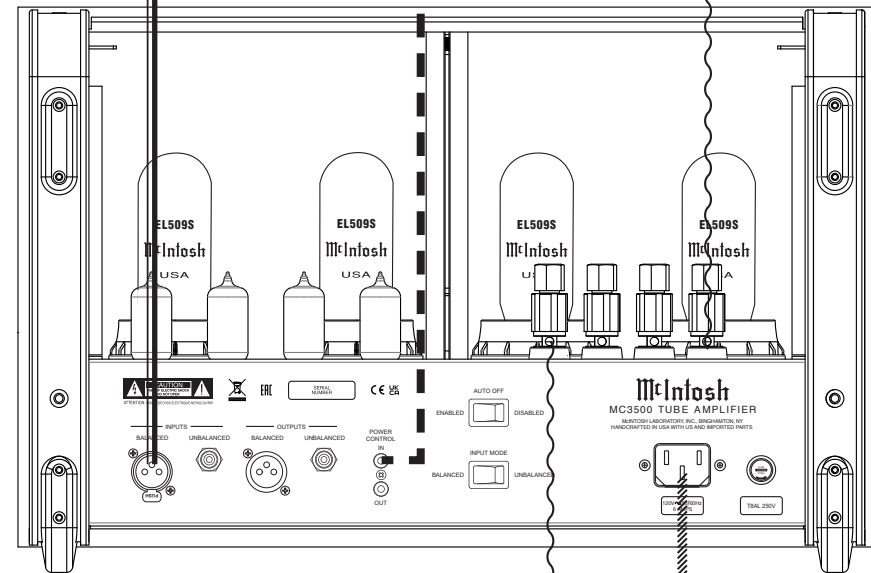

To  
AC Power Outlet

## How to Connect Loudspeakers

For the best performance and safety, it is important to always match the impedance of the Loudspeaker to the Power Amplifier connections. When connecting the Loudspeaker Hookup Cables to the MC3500 Power Amplifier Output Terminals please follow the steps below:

1. Rotate the top of the Output Terminal Post counterclockwise until an opening appears. Refer to figures A and B.

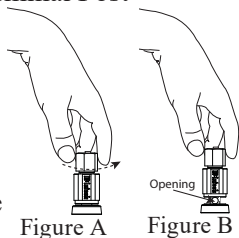

2. Insert the Loudspeaker hookup cable into the Output Terminal Post opening or the cable spade lug around the center post of the Output Terminal. Refer to figure C.

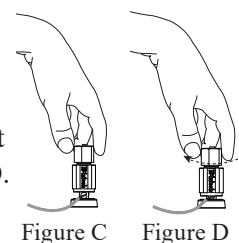

3. Rotate the top of the Output Terminal Post clockwise until it is finger tight. Refer to figure D.
4. Place the supplied McIntosh Wrench over the top of the Output Terminal and rotate it one quarter of a turn (90°) to secure the Loudspeaker Cable Connection. **Do not over tighten.** Refer to figure E.

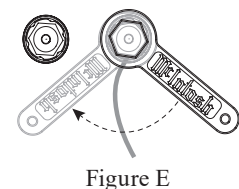

**WARNING: Do not connect the AC Power Cord to the MC3500 Rear Panel until after the Loudspeaker Connections are made. Failure to observe this could result in Electric Shock.**

The connection instructions below, together with the MC3500 Connection Diagram located on Page 9 is an example of a typical audio system. Your system may vary from this; however, the actual components would

be connected in a similar manner. For additional information, refer to “Connector and Cable Information” on Page 6.

1. For Remote Power Control, connect a power control cable from the Audio Preamplifier Power Control Main Output Jack to the Power Amplifier POWER CONTROL IN Jack.
2. Connect XLR cables from the Balanced Main Output connector of the Audio Preamplifier to the Power Amplifier Balanced INPUTS. Place the INPUT Switch in the Balanced Position.

*Note: An optional hookup is to use unbalanced cable and place the INPUT MODE Switch in the Unbalanced Position.*

This McIntosh MC3500 Power Amplifier is designed for Loudspeakers with an impedance of 2 ohms, 4 ohms, or 8 ohms. Connect a single Loudspeaker only to the Output Terminals.

When connecting Loudspeakers to the MC3500 it is very important to use cables of adequate size, so there is little to no power loss in the cables. The size is specified in AWG (American Wire Gauge). The smaller the Gauge number, the larger the wire size:

*Note: The impedance of a Loudspeaker actually varies as the Loudspeaker reproduces different frequencies. As a result, the nominal impedance rating of the Loudspeaker (usually measured at a midrange frequency) might not always agree with the impedance of the Loudspeaker at low frequencies where the greatest amount of power is required. Contact the Loudspeaker Manufacturer for additional information about the actual impedance of the Loudspeaker before connecting it to the McIntosh MC3500.*

Loudspeaker Cable Distance vs Wire Gauge Guide			
Loudspeaker Impedance	25 feet (7.62 meters) or less	50 feet (15.24 meters) or less	100 feet (30.48 meters) or less
2 Ohms	12AWG	10AWG	8AWG
4 Ohms	14AWG	12AWG	10AWG
8 Ohms	16AWG	14AWG	12AWG

3. Prepare the Loudspeaker Hookup Cable for attachment to the MC3500 Power Amplifier:

### Bare wire cable ends:

Carefully remove sufficient insulation from the cable ends, refer to figures 1, 2, and 3. If the cable is stranded, carefully twist the strands together as tightly as possible.

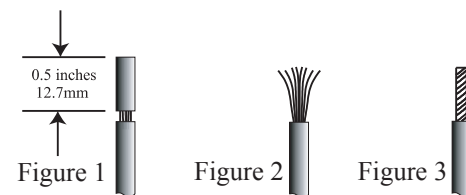

- Notes:*
1. If desired, the twisted ends can be tinned with solder to keep the strands together.
  2. The prepared bare wire cable ends may be inserted into spade lug connectors.
  3. Banana plugs are for use in the United States and Canada only.

### **Banana Plugs are for use in the United States and Canada only:**

4. Attach the previously prepared bare wire cable ends into the banana plugs and secure the connections. Refer to figure F.
5. Rotate the top of the Output Terminal Post clockwise until it is finger tight. Refer to figure G. Then using the McIntosh Wrench, rotate the top of the

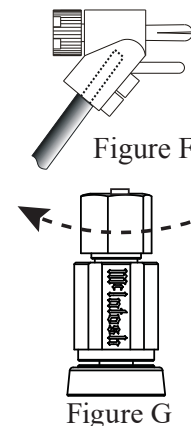

Output Terminal one quarter of a turn (90°). **Do not over tighten.** Refer to figure E.

6. Referring to figure H, connect the Loudspeaker hookup cables with banana plugs into the hole at the top of the MC3500 Negative (-) and Positive (+) Output Terminals. The Positive Terminals are identified as 2Ω (ohms), 4Ω (ohms) or 8Ω (ohms) connection to match the impedance of the Loudspeaker, being careful to observe the correct polarities.

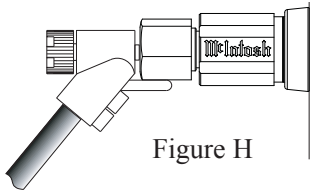

Figure H

If the Loudspeaker's impedance is in-between the available connections, use the nearest lower impedance connection.

**WARNING: Loudspeaker Terminals are hazardous live and present a risk of electric shock. For additional instruction on making Loudspeaker Connections, contact your McIntosh Dealer or McIntosh Technical Support.**

7. Connect the MC3500 Power Cord to an active AC outlet.

Spade Lug or Wire Connections:

8. Connect the Loudspeaker hookup cables to the MC3500 Negative Output Terminal (-) and Positive Output (+) Terminal identified as 2Ω (ohms), 4Ω (ohms) or 8Ω (ohms) connection to match the impedance of the Loudspeaker, being careful to observe the correct polarities. Insert the spade lug connector or prepared section of the cable end into the terminal side access hole, and

tighten the terminal cap until the cable is firmly clamped into the terminals so the lugs or wire cannot slip out. **Do not over tighten.** Refer to figures 4, 5, and figure E.

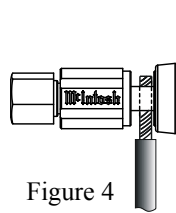

Figure 4

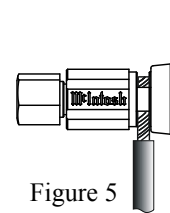

Figure 5

If the Loudspeaker's impedance is in-between the available connections, use the nearest lower impedance connection.

**WARNING: Loudspeaker terminals are hazardous live and present a risk of electric shock. For additional instruction on making Loudspeaker Connections contact your McIntosh Dealer or McIntosh Technical Support.**

9. For a Stereo system, repeat steps 2-8 for the other channel.
10. Connect the MC3500 Power Cord to an active AC outlet.



## Navigating the Front Panel

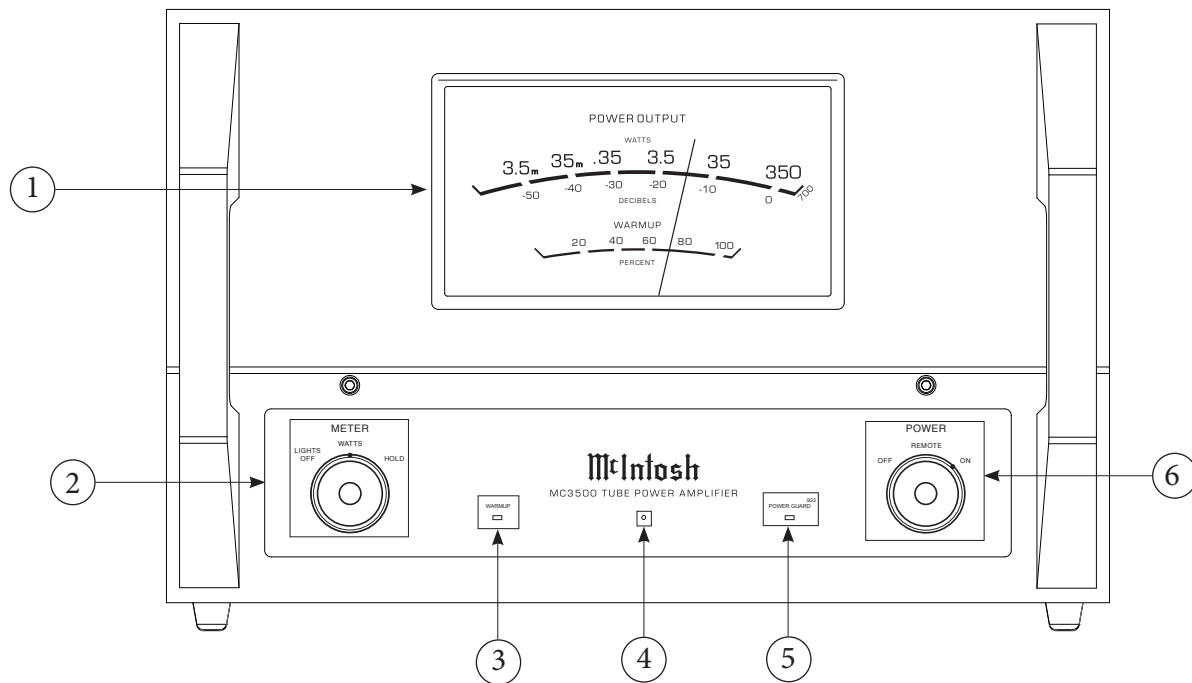

1. **Power Output Meter:** Displays power output level in Watts and Decibels.
2. **Meter Control Knob:** Select between the different Output Meter functions (see next page).
3. **Warmup LED:** Illuminates to indicate when Warmup state is active (see next page).
4. **Standby LED:** Illuminates whenever the MC3500 is connected to a live AC outlet. Flashes whenever Sentry Monitor has activated (see next page).

5. **Power Guard LED:** Illuminates to indicate when Power Guard is active.
6. **Power Knob:** Turn MC3500 On/Off, or set to REMOTE position to have it be turned On/Off automatically by a Preamplifier (see next page).

## How to Operate

### Power Control

The POWER CONTROL is located on the Front Panel of the MC3500. Set the Control to the REMOTE Position. Refer to figure 10. The MC3500 Power Amplifier will turn ON or OFF as the Preamplifier it is connected to (via the Power Control Connection) turns On or Off. For manual operation, place the POWER CONTROL to the ON Position as desired. The LED indicator located on the Front Panel is illuminated when the MC3500 is connected to an active AC Outlet.

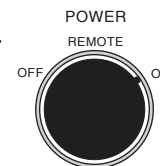

When the MC3500 is first switched On, there is a Warmup period of time during which no sound will be heard and the WARMUP LED will illuminate. During this period, the Power Output Meter needle will gradually rise to show the warmup percentage. After the needle reaches 100%, the MC3500 will begin playing sound, the WARMUP LED will switch off, and the needle will return to displaying the appropriate Output based on the Meter Control Knob position (see below).

### Meter Control

The Meter Control Knob changes how the Power Output Meter behaves. If the Knob is set to WATTS, the Meter will continuously respond to and display the current Output of the MC3500. Refer to figure 11.

If the Knob is set to HOLD, the Meter will display the highest peak Output in a series of peaks, until a greater peak is read. If no greater peak is read, the Meter will begin to lower at a rate of approximate 6dB per minute.

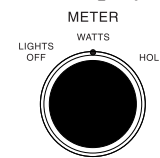

Figure 11

While the Knob is set to either WATTS or HOLD, the Power Output Meter light will be powered On/Off by a Preamplifier or A/V Control Center connected by a Power Control Cable if that unit has Power Control capabilities.

If the Knob is set to LIGHTS OFF, the Power Output Meter light will be permanently off, and the Meter will respond as if the Knob was set to WATTS.

### Input Switch

The Input Mode Switch, which is located on the Rear Panel of the MC3500, allows selection of either the Balanced or Unbalanced Input. Refer to figure 12.

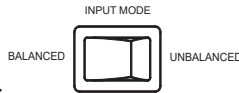

Figure 12

### Auto Off Switch

The MC3500 incorporates Power Save Circuitry to automatically place the MC3500 into the power saving Standby Mode approximately 30 minutes after there has been an absence of an audio input signal.

When there is a Power Control Connection between the MC3500 and a Preamplifier with Power Save Circuitry, the AUTO OFF Switch is bypassed (located on the Rear Panel of the MC3500). Refer to figure 13.

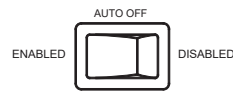

Figure 13

In the event there is no Power Control Connection and the Power Save Circuitry is activating inappropriately relative to your specific use of the MC3500, place the AUTO OFF Switch in the DISABLED position.

If the Power Save Circuitry has switched Power to the MC3500 OFF, place the POWER in the OFF Position and then in the ON position to reset the circuitry.

### Sentry Monitor Reset

Sentry Monitor provides protection for the MC3500 by monitoring Output. In the event of a large impedance mismatch, a short circuit at the Output Terminals, or Tube failure, Sentry Monitor will activate to prevent potentially destructive levels of current from flowing.

When Sentry Monitor is activated, the MC3500 will power off, and the Standby LED will flash.

To reset the Sentry Monitor Protection Circuitry, turn the Power Control Knob to OFF. (See “Power Control” on previous page). Then, turn the Power Control Knob to ON.

If Sentry Monitor continues to engage, the problem must be fixed before continuing. Check that wires connected to the Output Terminals and the Loudspeaker Terminals are not shorted. If those connections are fine, and the Impedance of the Loudspeakers is close to the value of the connected Output terminals, the issue may be a defective tube.

When the MC3500 doesn't return to Normal Operation after the Power Switch has been switched back ON, then place the Power Switch in the OFF position and disconnect the AC Power Cord from the MC3500. Then contact your McIntosh Dealer for repair of the Power Amplifier.



---

## Amplifier Specifications

---

### Power Output

350 watts into 2 ohm load  
350 watts into 4 ohm load  
350 watts into 8 ohm load

### Rated Power Band

20Hz to 20,000Hz

### Dynamic Headroom

2.4dB

### Wide Band Damping Factor

Greater than 25

### Frequency Response

+0, -0.5dB from 20Hz to 20,000Hz  
+0, -3.0dB from 10Hz to 70,000Hz

### Total Harmonic Distortion

0.3% maximum harmonic distortion at any power level  
from 250 milliwatts to rated power, 20Hz to 20,000Hz

### Intermodulation Distortion

0.3% maximum, if the instantaneous peak power output  
does not exceed twice the rated power output for any  
combination of frequencies from 20Hz to 20,000Hz

### Signal To Noise Ratio (A Weighted)

120dB below rated output

### Input Sensitivity (for rated output)

3.8 Volts Balanced  
1.9 Volts Unbalanced

### Voltage Gain

29dB, 8 Ohms  
26dB, 4 Ohms  
23dB, 2 Ohms

### Input Impedance

22,000 ohms Balanced  
22,000 ohms Unbalanced

---

## General Specifications

---

### Power Control Input

5-15VDC, less than 1mA

### Power Control Output

12VDC, 25mA (Delayed 0.2 seconds from power on)

### Power Requirements

100 Volts ~ 50/60Hz at 7.2 Amps  
110 Volts ~ 50/60Hz at 6.0 Amps  
120 Volts ~ 50/60Hz at 6.0 Amps  
127 Volts ~ 50/60Hz at 6.0 Amps  
220 Volts ~ 50/60Hz at 3.3 Amps  
230 Volts ~ 50/60Hz at 3.3 Amps  
240 Volts ~ 50/60Hz at 3.3 Amps  
Standby, less than 0.5 watt

*Refer to the rear panel of the MC3500 for the correct  
voltage.*

### Overall Dimensions

Depth is 21-5/8 inches (54.9cm)  
Width is 18 inches (45.7cm)  
Height is 11-13/16 inches (30cm)

### Weight

121 pounds (54.9kg) net  
147 pounds (66.7kg) in shipping carton

### Shipping Carton Dimensions

Depth is 31 inches (78.7cm)  
Width is 28 inches (71.1cm)  
Height is 17-1/4 inches (43.8cm)

## Packing Instructions

In the event it is necessary to repack the equipment for shipment, the equipment must be packed exactly as shown below. It is very important that the four feet are attached to the bottom of the equipment. This will ensure the proper equipment location on the bottom foam pad. Failure to do this will result in shipping damage.

To protect the tubes during shipment, the Foam Insert removed from the MC3500 needs to be re-inserted.  
Follow the unpacking instructions on pages 4-5 in the reverse order.

Use the original shipping carton and interior parts only if they are all in good serviceable condition. If a shipping carton or any of the interior part(s) are needed, please call or write Customer Service Department of McIntosh Laboratory, refer to page 2. Please see the Part List for the correct part numbers.

Quantity	Part Number	Description
1	034105	Shipping Carton Top
1	034104	Shipping Carton Bottom
1	034680	Tube Foam Insert
2	034679	Pad Top/Bottom
3	034678	Foam Ring
1	241109	Warning Sheet
1	033739	Poly Bag

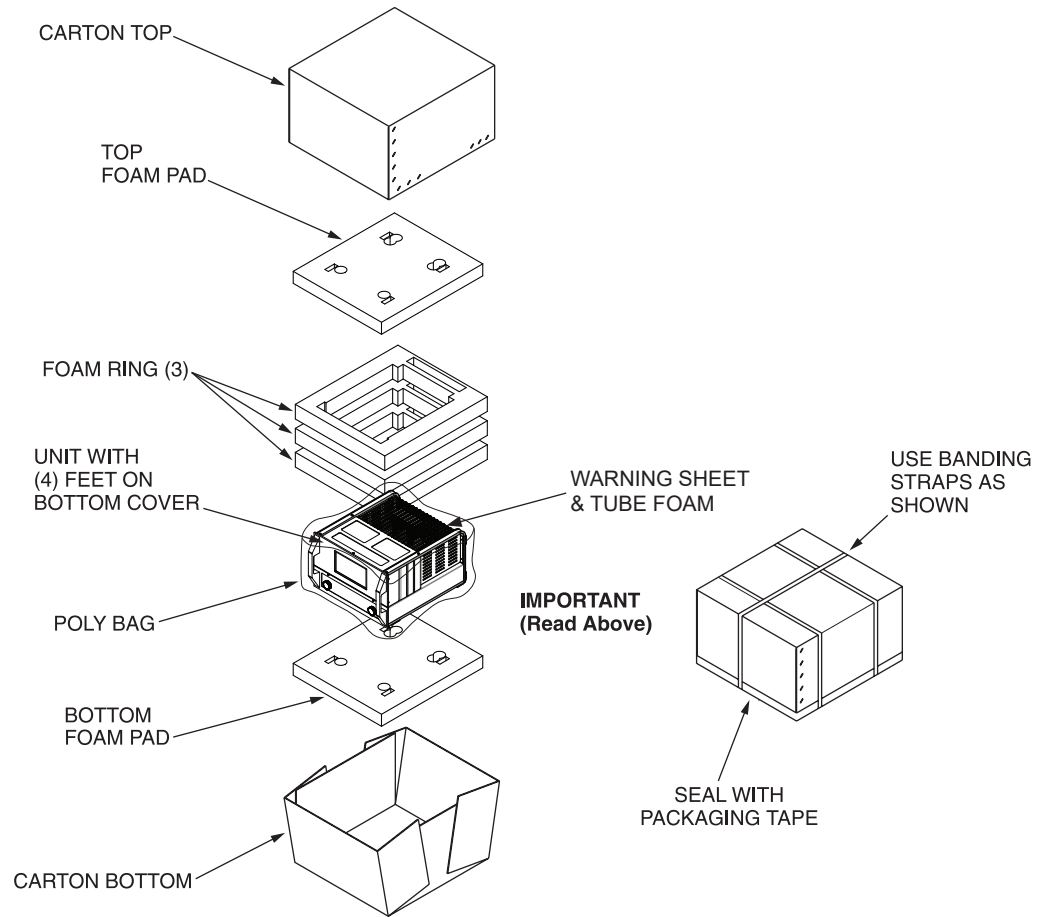



McIntosh Laboratory, Inc.  
2 Chambers Street  
Binghamton, NY 13903  
[www.mcintoshlabs.com](http://www.mcintoshlabs.com)

The continuous improvement of its products is the policy of McIntosh Laboratory Incorporated who reserve the right to improve design without notice.  
Printed in the U.S.A.