



McIntosh Laboratory, Inc. 2 Chambers Street Binghamton, New York 13903-2699 Phone: 607-723-3512 [www.mcintoshlabs.com](http://www.mcintoshlabs.com)

MI254  
Four Channel  
Power Amplifier  
Owner's Manual





## Important Safety Information is supplied in a separate document “Important Additional Operation Information Guide”

### Thank You

Your decision to own this McIntosh MI254 Four Channel Power Amplifier ranks you at the very top among discriminating music listeners. You now have “The Best.” The McIntosh dedication to “Quality,” is assurance that you will receive many years of musical enjoyment from this unit.

Please take a short time to read the information in this manual. We want you to be as familiar as possible with all the features and functions of your new McIntosh.

### Please Take A Moment

The serial number, purchase date and McIntosh Dealer name are important to you for possible insurance claim or future service. The spaces below have been provided for you to record that information:

Serial Number: \_\_\_\_\_

Purchase Date: \_\_\_\_\_

Dealer Name: \_\_\_\_\_

### Technical Assistance

If at any time you have questions about your McIntosh product, contact your McIntosh Dealer who is familiar with your McIntosh equipment and any other brands that may be part of your system. If you or your Dealer wish additional help concerning a suspected problem, you can receive technical assistance for all McIntosh products at:

McIntosh Laboratory, Inc.  
2 Chambers Street  
Binghamton, New York 13903  
Phone: 607-723-3512  
Fax: 607-724-0549

### Customer Service

If it is determined that your McIntosh product is in need of repair, you can return it to your Dealer. You can also return it to the McIntosh Laboratory Service Department. For assistance on factory repair return procedure, contact the McIntosh Service Department at:

McIntosh Laboratory, Inc.  
2 Chambers Street  
Binghamton, New York 13903  
Phone: 607-723-3515  
Fax: 607-723-1917

### Table of Contents

Safety Instructions .....	2
(Separate Sheet) .....	<b>Important Additional Operation Information Guide</b>
Thank You and Please Take a Moment.....	2
Technical Assistance and Customer Service .....	2
Table of Contents .....	2
General Information .....	2
Connector and Cable Information .....	3
Introduction.....	3
Performance Features .....	3
Dimensions .....	4
Installation .....	5
Rear Panel Connections, Switches and Selection....	6-7
Output Terminals and How to Connect .....	8-13
Front Panel Displays and Push-button .....	14
How to Operate.....	15
Photos.....	16-17
Specifications.....	18
Packing Instruction.....	19

### General Information

1. For additional connection information, refer to the owner’s manual(s) for any component(s) connected to the MI254.

2. The MI254 mutes the speaker output for approximately two seconds when first turned on.
3. Included with the MI254 and located in the Owner’s Manual Packet are two Side Rack Mounted Brackets and screw fasteners. Below are graphic images of the MI254 with and without the Side Rack Mounted Brackets attached. Refer to page 5 for installing the Side Rack Mount Brackets.

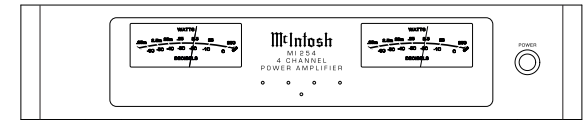

MI254 4 Channel Power Amplifier

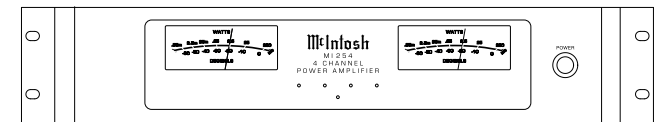

MI254 4 Channel Power Amplifier with Side Rack Mount Brackets installed

4. For the best performance and safety it is important to always attach a single Loudspeaker with an 8 Ohm or 4 Ohm impedance to the Channel 1 - Channel 4 output terminals. Refer to “How to Connect” pages 8 thru 13.

*Note: The impedance of a Loudspeaker actually varies as the Loudspeaker reproduces different frequencies. As a result, the nominal impedance rating of the Loudspeaker (usually measured at a midrange frequency) might not always agree with the impedance of the Loudspeaker at low frequencies where the greatest amount of power is required. Contact the Loudspeaker Manufacturer for additional information about the actual impedance of the Loudspeaker before connecting it to the McIntosh MI254.*

Copyright 2018 © by McIntosh Laboratory, Inc.

5. In the event the MI254 Channel(s) over heat, due to improper ventilation or Loudspeaker Impedance, the protection circuits will activate. The Front Panel Channel LED will change color and the audio will be muted. Refer to page 15. When the MI254 has returned to a safe operating temperature, Channel(s) normal operation will resume.
6. For additional information on the MI254 and other McIntosh Products please visit the McIntosh Website at [www.mcintoshlabs.com](http://www.mcintoshlabs.com).

## Connector and Cable Information

### XLR Connectors

Below is the Pin configuration for the XLR Balanced Input, Input/Output Connectors on the MI254. Refer to the diagram for connection:

- PIN 1: Shield/Ground
- PIN 2: + Input/Output
- PIN 3: - Input/Output

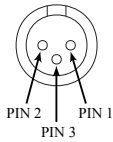

### Power Control Connector

The MI254 Power Control Input receives an On/Off signal from +5 to +12 volts. The Power Control Output will in turn provide a +12 volt Output Signal with a total current up to 50mA. An additional connection is for controlling the illumination of the MI254 Meter Power Output Indicators. The 3.5mm stereo mini phone plug connects to a McIntosh Preamplifier or A/V Control Center Power Control Output.

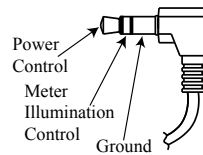

### Output Terminal Connector

When cables with spade lugs are used for Loudspeaker Connection, the spade lugs need an opening of at least 3/10 inch (7.6mm)

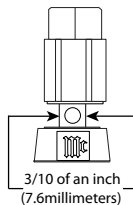

## Introduction

Now you can take advantage of traditional McIntosh standards of excellence in the MI254 Power Amplifier. The Four Channel Power Amplifier produces high power output per channel and will drive quality Loudspeakers to a high level of performance. The MI254 reproduction is sonically transparent and absolutely accurate. The McIntosh Sound is “The Sound of the Music Itself.”

## Performance Features

### • Power Output

The MI254 consists of Four Power Amplifier Channels, each capable of 250 watts into 8 ohms 300 watts into 4 ohms Loudspeakers with distortion less than 0.025%.

### • Loudspeaker Guard

The McIntosh Loudspeaker Guard Circuit prevents the amplifier from being over driven into clipping, with its harsh distorted sound that can damage your valuable Loudspeakers.

### • Versatile Operation

The MI254 can provide power amplification for four channels in a single Zone A/V System or two channels for each of a Dual Zone A/V System.

### • Balanced, Unbalanced and Bus Inputs

There are Balanced, Unbalanced and Bus Connections for all four Power Amplifier Input Channels.

### • Sentry Monitor and Thermal Protection

McIntosh Sentry Monitor power output stage protection circuits ensure the MI254 will have a long and trouble free operating life. Built-in Thermal Protection circuits guard against overheating.

### • Illuminated Power Meters

The Illuminated Power Output Watt Meters on the MI254 are peak responding, and indicates the Power Output of the amplifiers.

### • Power Control

The McIntosh Power Control Circuit allows for remote turn-on of the MI254 Power Amplifier from a McIntosh A/V Control Center or Preamplifier for a single or dual Zone System.

### • Special Power Supply

A regulated Power Supply ensures stable noise free operation even though the power line varies.

### • LED Solid State Front Panel Illumination

The even Illumination of the Front Panel is accomplished by extra long life Light Emitting Diodes (LEDs). The Metal and Glass Front Panel ensures the pristine beauty of the MI254 will be retained for many years.



### Dimensions

The following dimensions can assist in determining the best location for your MI254.

Front View of the MI254

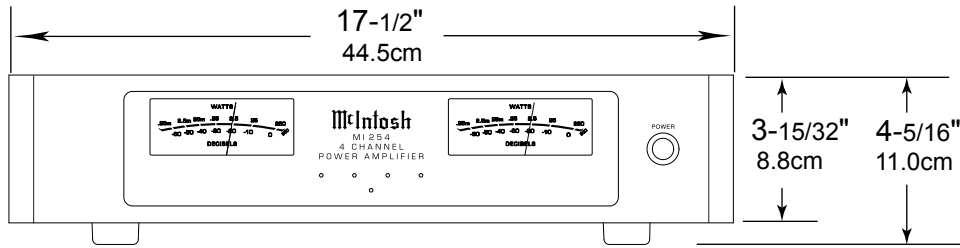

Front View of the MI254 with Side Mount Brackets

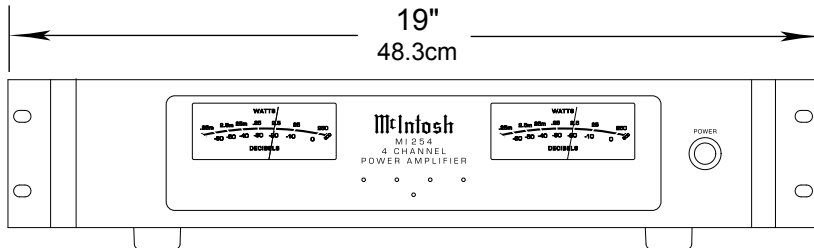

Rear View of the MI254

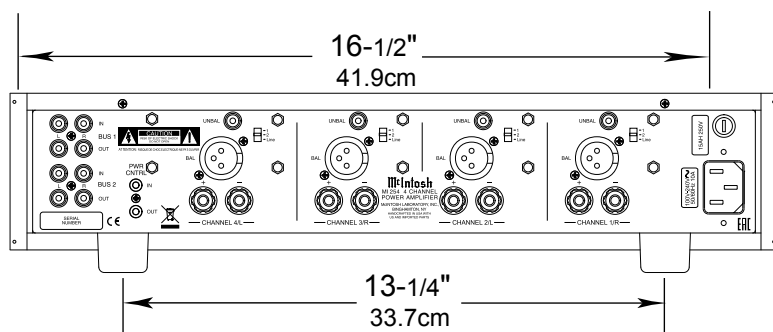

Side View of the MI254

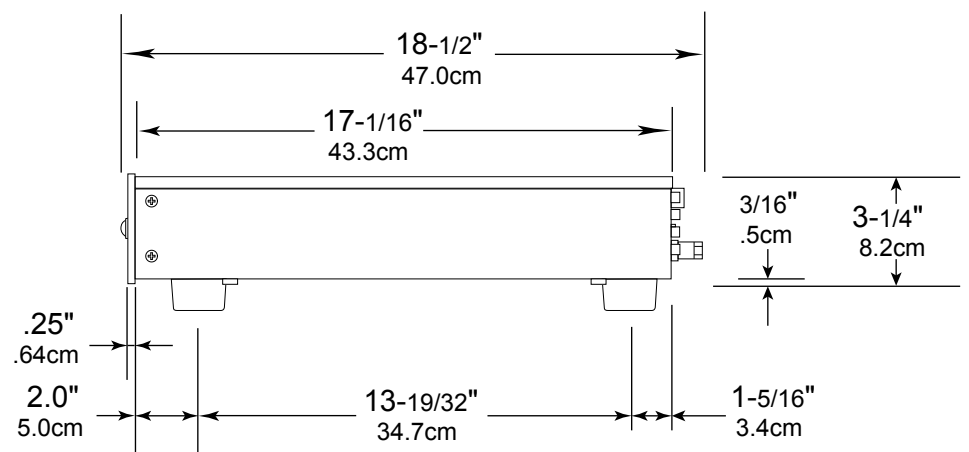

## Installation

The MI254 needs to be placed upright on its four feet. It also can be custom installed. Remove the four feet when it is custom installed and retain them with the fastening screws for possible future use. The required panel cutout, ventilation cutout and unit dimensions are shown in the drawing on the right side of this page.

It is necessary to provide adequate ventilation for cool operation, ensuring long life for the MI254. Do not install the MI254 above heat generating components. When the MI254 is installed in a cabinet with other components, use a ventilation fan to provide cool operating temperature.

A custom cabinet installation needs to provide the following minimum spacing for cool operation:

Allow at least 3 inches (7.6cm) above the top, 2 inches (5.08cm) below the bottom, 3 inches (7.62cm) behind the rear panel and 2 inches (5.08cm) on each side of the MI254, providing airflow. Allow 2-1/2 inches (6.35 cm) in front of the mounting<sup>1</sup> panel for clearance. Be sure to cut out a ventilation hole in the mounting shelf according to the dimensions in the drawing.

<sup>1</sup> When the MI254 is installed together with other McIntosh Components, check clearances on all components before proceeding.

## Installation of Side Rack Mount Brackets

When desired, to install MI254 Side Rack Mounting Brackets, follow the steps below for one side at a time:

1. Refer to figure A to remove the two side screws and save them for possible future use.
2. Position the Side Rack Mounting Bracket as illustrated in figure B. Then attach the Bracket to the Front and Side Panel of the MI254, using the screws supplied with the Bracket.
3. Perform steps 1 and 2 to mount the second Bracket to the other side of the MI254.

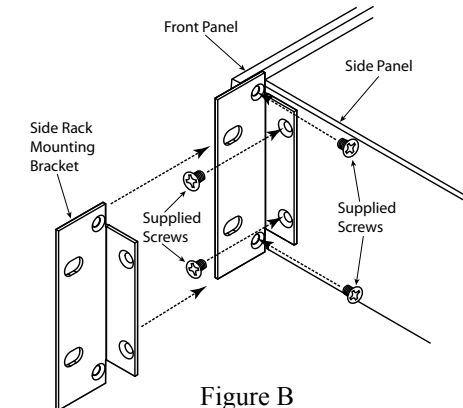
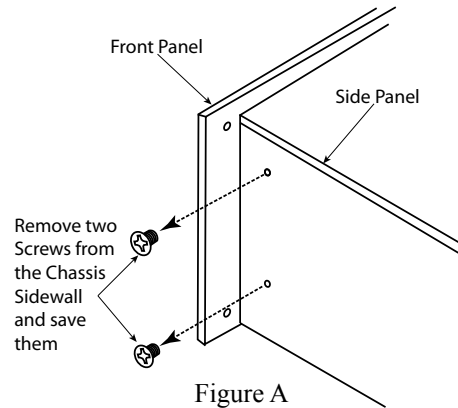
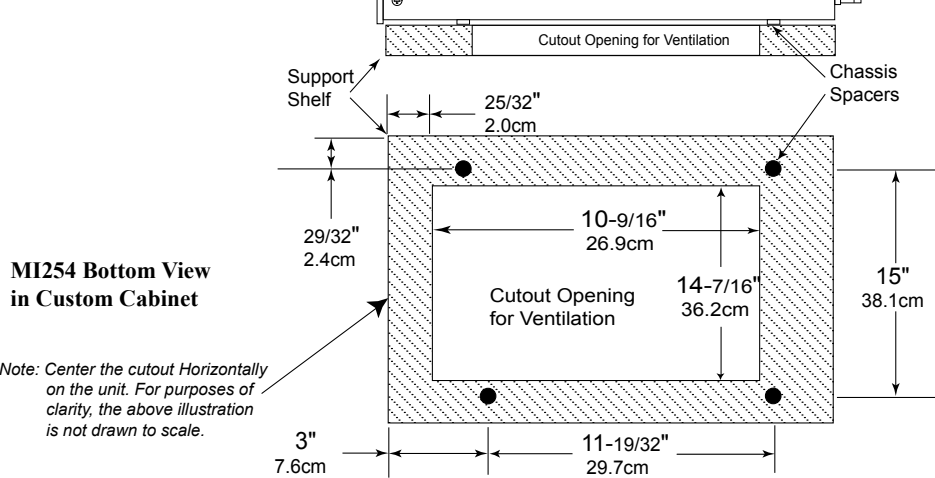
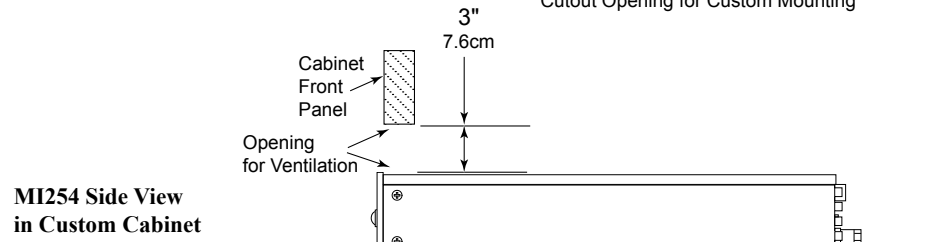
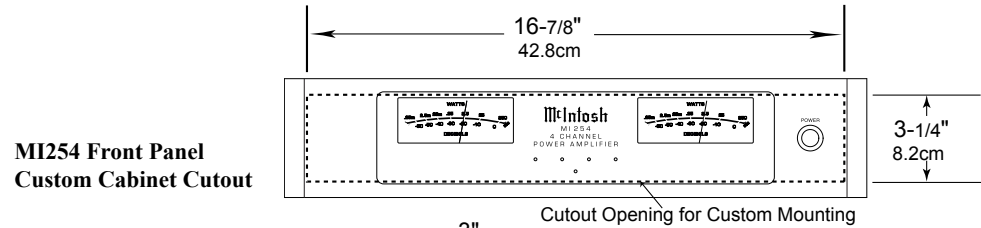



# Rear Panel Connections and Switches

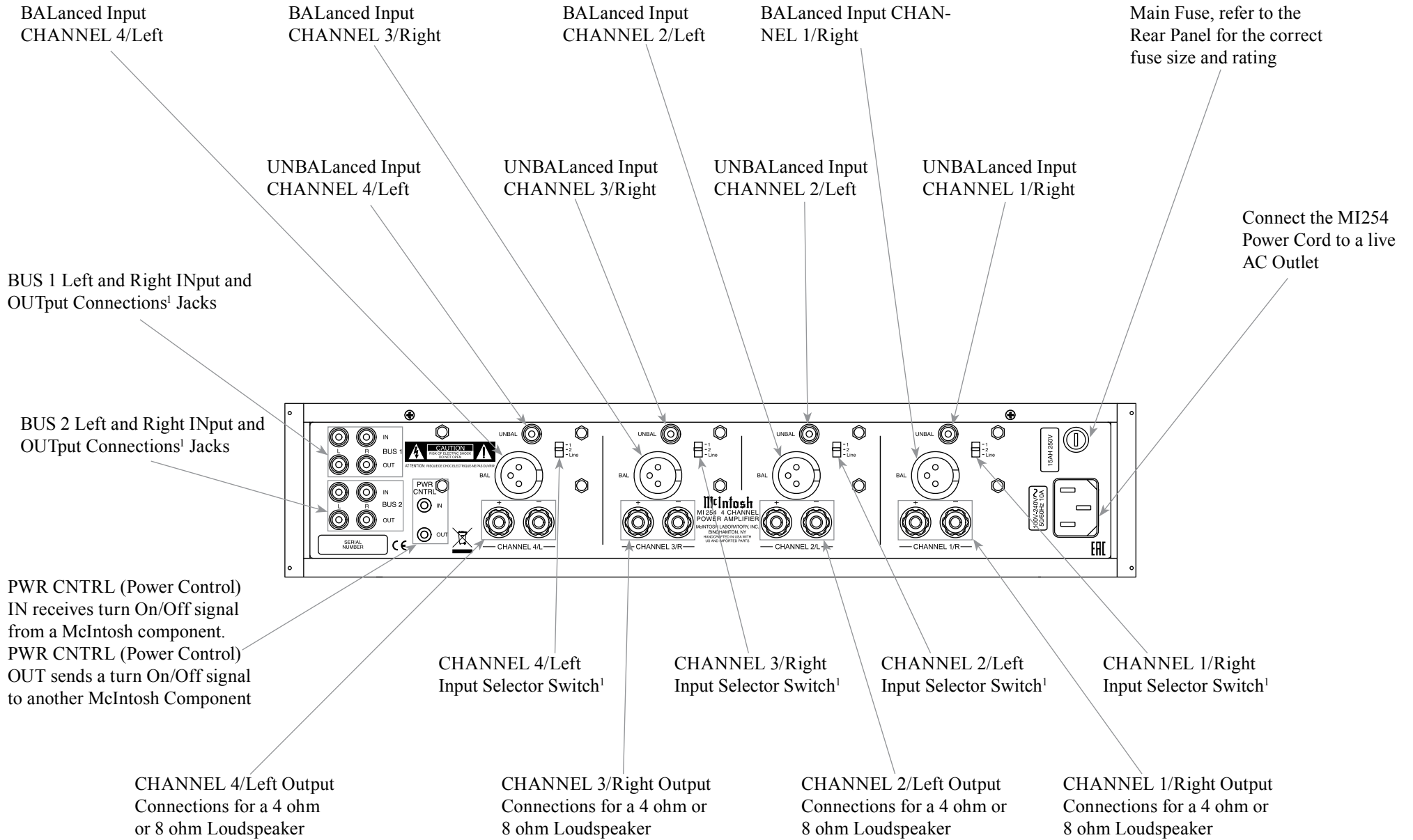

<sup>1</sup> Refer to page 7 for detailed information about utilization of the CHANNEL 1-4 Input Switches and the functioning of the BUS 1-2 Input and OUTput connection jacks

### Audio Input Selection for each Power Amplifier Channel

Each Channel of the MI254 allows selection of different Audio Signal Inputs to be Amplified via a three position switch (1, 2, LINE). The BUS 1 (Left or Right Inputs) and BUS 2 (Left or Right Inputs) Audio Signals are available to the respective Channel Left or

Right. Each Channel of the MI254 also has UNBALANCED and BALANCED Inputs. The three position switch (Channel 4/L) needs to be placed in the LINE Position when there is a connection via the UNBALANCED and BALANCED Input Connector.

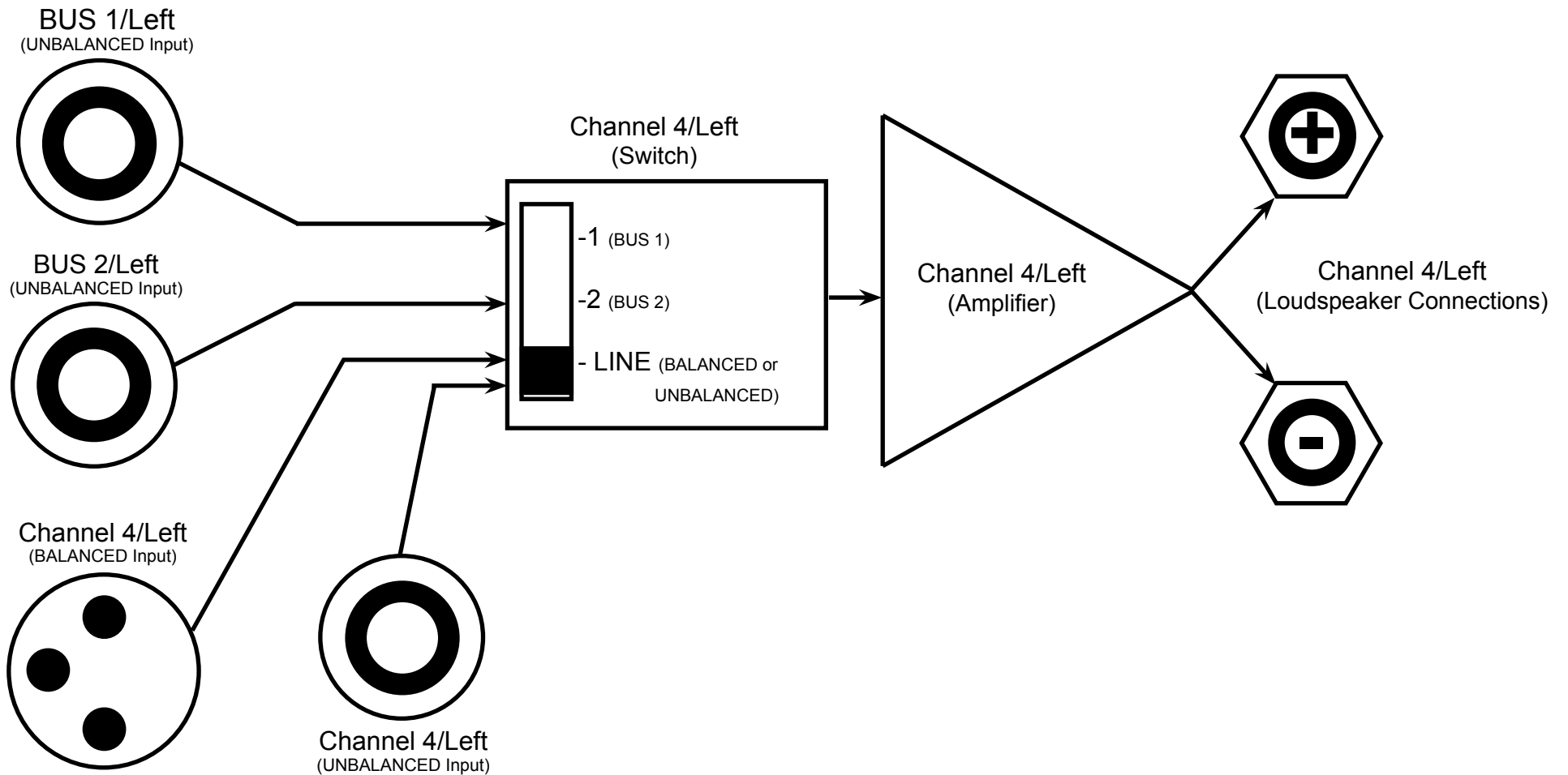



## Output Terminals

When connecting the Loudspeaker Hookup Cables to the MI254 Amplifier Output Terminals please follow the steps below:

1. Rotate the top of the Output Terminal Post counterclockwise until an opening appears. Refer to figures A and B.
2. Insert the Loudspeaker hookup cable into the Output Terminal Post opening or the cable spade lug around the center post of the Output Terminal. Refer to figure C.
3. Rotate the top of the Output Terminal Post clockwise until it is finger tight. Refer to figure D.
4. Place the supplied McIntosh Wrench over the top of the Output Terminal and rotate it one quarter of a turn (90°) to secure the Loudspeaker Cable Connection. **Do not over tighten.** Refer to figure E.

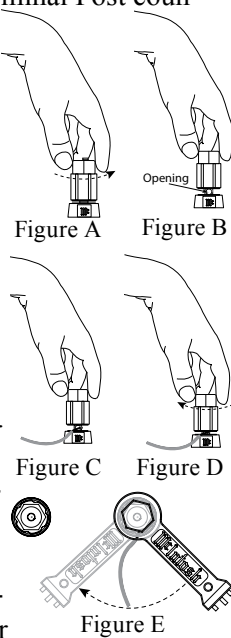

## How to Connect for Multi Channel System

**Caution: Do not connect the AC Power Cord to the MI254 Rear Panel until after the Loudspeaker Connections are made. Failure to observe this could result in Electric Shock.**

The connection instructions below, together with the MI254 Connection Diagram located on the separate folded sheet “Mc1A”, is an example of a typical Multichannel System. Your system may vary from this, however the actual components would be connected in a similar manner. For additional information refer to

“Connector and Cable Information” on page 3.

1. For Remote Power Control, connect a power control cable from the A/V Control Center Power Control Trigger/Output 1 to the Amplifier PWR CNTRL Power Control Input.

*Note: When the Power Control Cable is connected between the MI254 and an A/V Control Center, the AUTO OFF Signal Sensing Circuitry is automatically disabled.*

2. Connect XLR cables from the Balanced Outputs (HR1, HL1, HR2, and HL2) of an A/V Control Center to the MI254 BALANCED INPUTS (CHANNELS - 1/R, 2/L, 3/R and 4/L ) making sure to match up channel designations.

*Note: The MI254 UNBALANCED Inputs may be used in place of the Balanced Inputs when the A/V Control Center has Unbalanced Output Connections instead of Balanced Connections.*

3. Place the Input Selector Switches for all four channels in the “LINE” position.

This McIntosh MI254 Power Amplifier is designed for Loudspeakers with an impedance of 4 ohms or 8 ohms. Connect a single Loudspeaker only to each Channel Output Terminals.

When connecting Loudspeakers to the MI254 it is very important to use cables of adequate size, so there is little to no power loss in the cables. The size is specified in Gauge Numbers or AWG (American Wire Gauge). The smaller the Gauge number, the larger the wire size:

Loudspeaker Cable Distance vs Wire Gauge Guide			
Loudspeaker Impedance	25 feet (7.62 meters) or less	50 feet (15.24 meters) or less	100 feet (30.48 meters) or less
4 Ohms	14AWG	12AWG	10AWG
8 Ohms	16AWG	14AWG	12AWG

4. Prepare the Loudspeaker Hookup Cable for attachment to the MI254 Power Amplifier:

Bare wire cable ends:

Carefully remove sufficient insulation from the cable ends, refer to figures 1, 2 & 3. If the cable is stranded, carefully twist the strands together as tightly as possible.

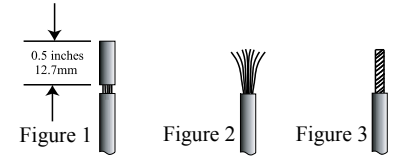

- Notes:*
1. If desired, the twisted ends can be tinned with solder to keep the strands together.
  2. The prepared bare wire cable ends may be inserted into spade lug connectors.
  3. Banana plugs are for use in the United States and Canada only.

**Banana Plugs are for use in the United States and Canada only:**

5. Attach the previously prepared bare wire cable ends into the banana plugs and secure the connections. Refer to figure 4.
6. Referring to figure 5, connect the Loudspeaker hookup cables with banana plugs into the hole at the end of the MI254 Negative and Positive Output Terminals, making sure to match up channel designation with Loudspeaker location.

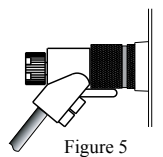
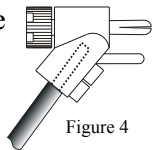

**WARNING: Loudspeaker terminals**

**are hazardous live and present a risk of electric shock. For additional instruction on making Loudspeaker Connections contact your McIntosh Dealer or McIntosh Technical Support.**



7. Connect the MI254 power cord to an active AC outlet.

### Spade Lug or Wire Connections:

8. Connect the Loudspeaker hookup cables to the MI254 Output Terminal being careful to observe the correct polarities, making sure to match up channel designation with Loudspeaker location. Insert the spade lug connector or prepared section of the cable end into the terminal side access hole. Then tighten the terminal cap until the cable is firmly clamped into the terminals so the lugs or wire cannot slip out. Refer to figures 6, 7 and 8.

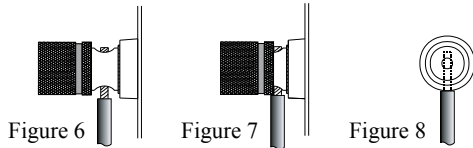

***WARNING: Loudspeaker terminals are hazardous live and present a risk of electric shock. For additional instruction on making Loudspeaker Connections contact your McIntosh Dealer or McIntosh Technical Support.***

9. Connect the MI254 power cord to an active AC outlet.



## Output Terminals

When connecting the Loudspeaker Hookup Cables to the MI254 Amplifier Output Terminals please follow the steps below:

1. Rotate the top of the Output Terminal Post counterclockwise until an opening appears. Refer to figures A and B.
2. Insert the Loudspeaker hookup cable into the Output Terminal Post opening or the cable spade lug around the center post of the Output Terminal. Refer to figure C.
3. Rotate the top of the Output Terminal Post clockwise until it is finger tight. Refer to figure D.
4. Place the supplied McIntosh Wrench over the top of the Output Terminal and rotate it one quarter of a turn (90°) to secure the Loudspeaker Cable Connection. **Do not over tighten.** Refer to figure E.

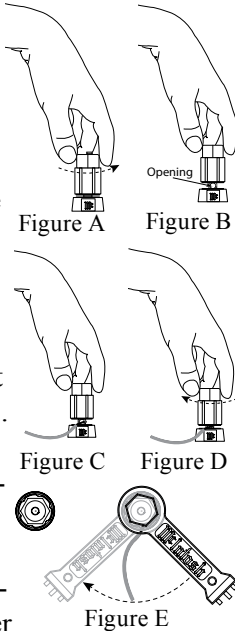

## How to Connect Different Sources for Zones B and C System

**Caution:** Do not connect the AC Power Cord to the MI254 Rear Panel until after the Loudspeaker Connections are made and the protective Terminal Connections Cover is installed. Failure to observe this could result in Electric Shock.

The connection instructions below, together with the MI254 Connection Diagram located on the separate folded sheet “Mc1B”, is an example of Different Sources for a Zone B and Zone C System. Your system may vary from this, however the actual compo-

nents would be connected in a similar manner. For additional information refer to “Connector and Cable Information” on page 3.

1. The Power Control Connection between the MI254 and a Multi Zone A/V Control Center provides automatic Power Control of the MI254. The internal settings of the A/V Control Center can provide the Power Control Function so the MI254 will be switched On when either Zone B, Zone C or both Zones are active. Connect a Power Control Cable from the A/V Control Center TRIG 2 jack to the MI254 PWR CNTRL IN Jack.

*Note: The AUTO OFF Signal Sensing Circuitry is automatically activated when there is no Power Control Cable connected to the MI254 and only Zone C is being used.*

2. Connect unbalanced cables from the A/V Control Center Analog Audio Out Zone 2 (Left and Right Channel) to the MI254 BUS 1 INPUTS, making sure to match up channel designations.
3. Connect unbalanced cables from the A/V Control Center Analog Audio Out Zone 3 (Left and Right Channel) to the MI254 BUS 2 INPUTS, making sure to match up channel designations.
4. Place the CHANNEL 1/R and 2/L Input Selector Switches to the “-1” Position.
5. Place the CHANNEL 3/R and 4/L Input Selector Switches to the “-2” Position.

This McIntosh MI254 Power Amplifier is designed for Loudspeakers with an impedance of 4 ohms or 8 ohms. Connect a single Loudspeaker only to each Channel Output Terminals.

When connecting Loudspeakers to the MI254 it is very important to use cables of adequate size, so there is little to no power loss in the cables. The size is specified in Gauge Numbers or AWG (American Wire

Gauge). The smaller the Gauge number, the larger the wire size:

Loudspeaker Cable Distance vs Wire Gauge Guide			
Loudspeaker Impedance	25 feet (7.62 meters) or less	50 feet (15.24 meters) or less	100 feet (30.48 meters) or less
4 Ohms	14AWG	12AWG	10AWG
8 Ohms	16AWG	14AWG	12AWG

6. Prepare the Loudspeaker Hookup Cable for attachment to the MI254 Power Amplifier:

Bare wire cable ends:

Carefully remove sufficient insulation from the cable ends, refer to figures 1, 2 & 3.

If the cable is stranded, carefully twist the strands together as tightly as possible.

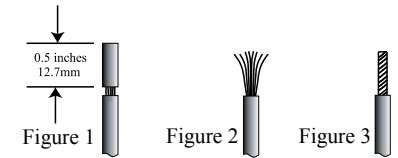

- Notes:*
1. If desired, the twisted ends can be tinned with solder to keep the strands together.
  2. The prepared bare wire cable ends may be inserted into spade lug connectors.
  3. Banana plugs are for use in the United States and Canada only.

**Banana Plugs are for use in the United States and Canada only:**

7. Attach the previously prepared bare wire cable ends into the banana plugs and secure the connections. Refer to figure 4.

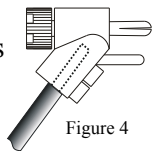

8. Referring to figure 5, connect the Loudspeaker hookup cables with banana plugs into the hole at the end of the MI254 Negative and Positive Output Terminals, making sure to

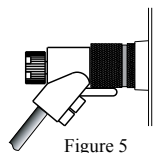

match up channel designation with Loudspeaker location.

**WARNING: Loudspeaker terminals are hazardous live and present a risk of electric shock. For additional instruction on making Loudspeaker Connections contact your McIntosh Dealer or McIntosh Technical Support.**

9. Connect the MI254 power cord to an active AC outlet.

### Spade Lug or Wire Connections:

10. Connect the Loudspeaker hookup cables to the MI254 Output Terminal being careful to observe the correct polarities, making sure to match up channel designation with Loudspeaker location. Insert the spade lug connector or prepared section of the cable end into the terminal side access hole. Then tighten the terminal cap until the cable is firmly clamped into the terminals so the lugs or wire cannot slip out. Refer to figures 6, 7 and 8.

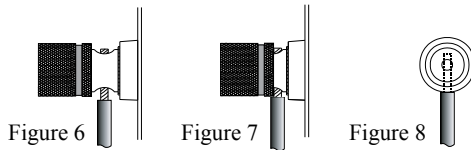

**WARNING: Loudspeaker terminals are hazardous live and present a risk of electric shock. For additional instruction on making Loudspeaker Connections contact your McIntosh Dealer or McIntosh Technical Support.**

11. Connect the MI254 power cord to an active AC outlet.



## Output Terminals

When connecting the Loudspeaker Hookup Cables to the MI254 Amplifier Output Terminals please follow the steps below:

1. Rotate the top of the Output Terminal Post counterclockwise until an opening appears. Refer to figures A and B.
2. Insert the Loudspeaker hookup cable into the Output Terminal Post opening or the cable spade lug around the center post of the Output Terminal. Refer to figure C.
3. Rotate the top of the Output Terminal Post clockwise until it is finger tight. Refer to figure D.
4. Place the supplied McIntosh Wrench over the top of the Output Terminal and rotate it one quarter of a turn (90°) to secure the Loudspeaker Cable Connection. **Do not over tighten.** Refer to figure E.

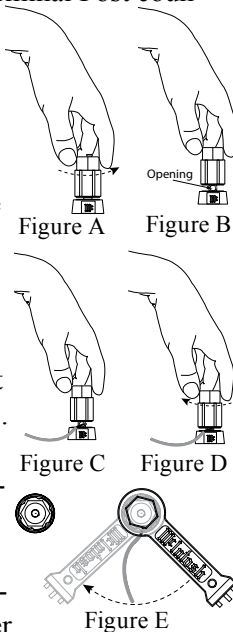

## How to Connect Same Source for Zones B and C System

**Caution:** Do not connect the AC Power Cord to the MI254 Rear Panel until after the Loudspeaker Connections are made and the protective Terminal Connections Cover is installed. Failure to observe this could result in Electric Shock.

The connection instructions below, together with the MI254 Connection Diagram located on the separate folded sheet “Mc1C”, is an example of Same Source for a Zone B and Zone C System. Your system may vary from this, however the actual components would

be connected in a similar manner. For additional information refer to “Connector and Cable Information” on page 3.

1. The Power Control Connection between the MI254 and a Music Streamer provides automatic Power Control of the MI254.  
*Note: The AUTO OFF Signal Sensing Circuitry is automatically activated when there is no Power Control Cable connected to the MI254 and only Zone C is being used.*
2. Connect unbalanced cables from the Music Streamer Unbalanced Audio Output (Left and Right Channel) to the MI254 BUS 1 INPUTS, making sure to match up channel designations.
3. Place the CHANNEL 1/R, 2/L, 3/R and 4/L Input Selector Switches to the “-1” Position.

This McIntosh MI254 Power Amplifier is designed for Loudspeakers with an impedance of 4 ohms or 8 ohms. Connect a single Loudspeaker only to each Channel Output Terminals.

When connecting Loudspeakers to the MI254 it is very important to use cables of adequate size, so there is little to no power loss in the cables. The size is specified in Gauge Numbers or AWG (American Wire Gauge). The smaller the Gauge number, the larger the wire size:

Loudspeaker Cable Distance vs Wire Gauge Guide			
Loudspeaker Impedance	25 feet (7.62 meters) or less	50 feet (15.24 meters) or less	100 feet (30.48 meters) or less
4 Ohms	14AWG	12AWG	10AWG
8 Ohms	16AWG	14AWG	12AWG

4. Prepare the Loudspeaker Hookup Cable for attachment to the MI254 Power Amplifier:  
Bare wire cable ends:  
Carefully remove sufficient insulation from

the cable ends, refer to figures 1, 2 & 3.

If the cable is stranded, carefully twist the strands together as tightly as possible.

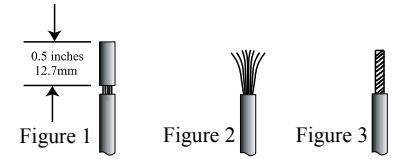

- Notes:*
1. If desired, the twisted ends can be tinned with solder to keep the strands together.
  2. The prepared bare wire cable ends may be inserted into spade lug connectors.
  3. Banana plugs are for use in the United States and Canada only.

## Banana Plugs are for use in the United States and Canada only:

5. Attach the previously prepared bare wire cable ends into the banana plugs and secure the connections. Refer to figure 4.
6. Referring to figure 5, connect the Loudspeaker hookup cables with banana plugs into the hole at the end of the MI254 Negative and Positive Output Terminals, making sure to match up channel designation with Loudspeaker location.

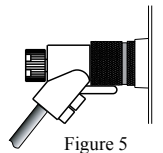
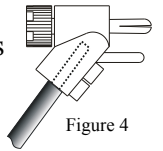

**WARNING:** Loudspeaker terminals are hazardous live and present a risk of electric shock. For additional instruction on making Loudspeaker Connections contact your McIntosh Dealer or McIntosh Technical Support.

7. Connect the MI254 power cord to an active AC outlet.

### Spade Lug or Wire Connections:

8. Connect the Loudspeaker hookup cables to the MI254 Output Terminal being careful to observe the correct polarities, making sure to match up channel designation with Loudspeaker location. Insert the spade lug connector or prepared section of the cable end into the terminal side access hole. Then tighten the terminal cap until the cable is firmly clamped into the terminals so the lugs or wire cannot slip out. Refer to figures 6, 7 and 8.

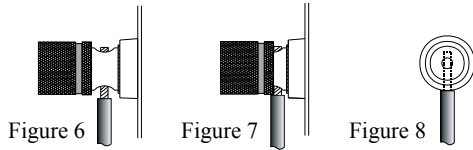

***WARNING: Loudspeaker terminals are hazardous live and present a risk of electric shock. For additional instruction on making Loudspeaker Connections contact your McIntosh Dealer or McIntosh Technical Support.***

9. Connect the MI254 power cord to an active AC outlet.

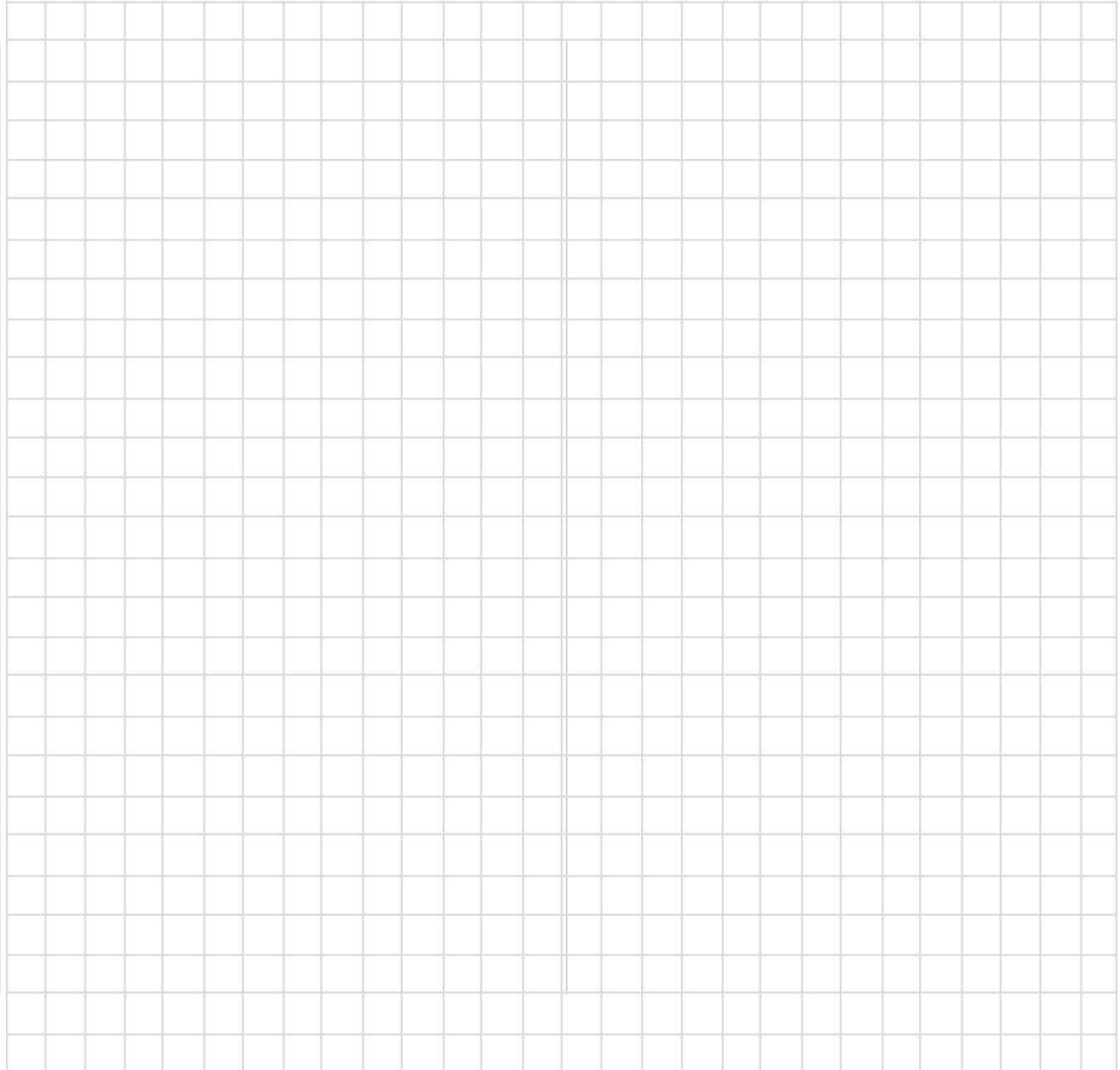

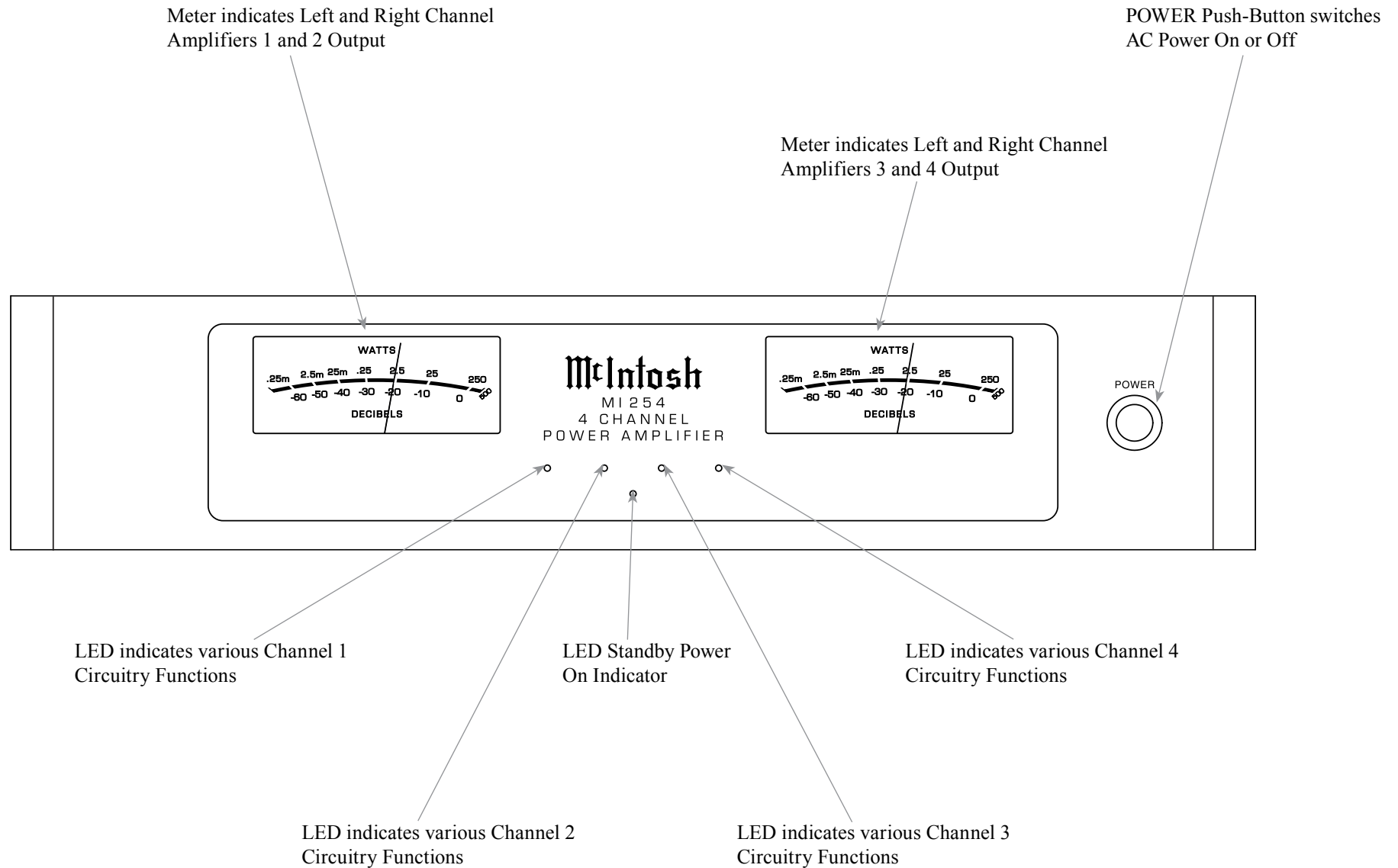

## How to Operate

### Power On

The LED STANDBY/ON Indicator illuminates to indicate the MI254 is connected to AC Power. To switch ON the MI254, press the POWER Push-button on the Front Panel or switch On the Audio Source Component providing there is a Power Control Cable Connection to the MI254. Refer to figure 20.

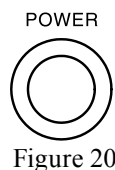

Figure 20

*Notes: 1. It will take about 6 seconds for initialization of the internal circuitry to take place on the MI254 when switched On.*

2. *There must be a power control connection between the MI254 and the Audio Source Component in order for the Remote Control Operation Power ON/OFF to function.*
3. *When the MI254 is receiving a Power Control ON Signal, the Front Panel POWER Push-Button becomes inactive.*

### Auto Off Function

The MI254 incorporates Power Save Circuitry to automatically place the MI254 into the power saving Standby Mode approximately 30 minutes after there has been an absence of an audio input signal on all four channels.

When there is a Power Control Connection between the MI254 and a Preamplifier or Source Component, the AUTO OFF Function is bypassed.

### Channel Operational Indication

The MI254 Front Panel has four LEDs. The LEDs indicate the current functioning status for each of the four channels.

MI254 Channel Operation Functions	
LED COLOR	Functional Status
LED not Illuminated	Indicates when the Channel is OFF
Green	Indicates when the Channel is ON with an Audio Signal Present and Normal Operation for the Channel exists
Amber	Indicates when maximum Power Output for the Channel has occurred with prevention of Audio Clipping
Red	Indicates current limit or short circuit for the Channel Loudspeaker Output Connection

### Power Output Meters

Both of the MI254 Power Output Meters indicate two Amplifier Channels Outputs at the same time. The Right Meter indicates Channels 3/R and 4/L. The Left Meter indicates Channels 1/R and 2/L.

The MI254 Power Output Meters indicate the power delivered to the Loudspeakers. Refer to figure 21.

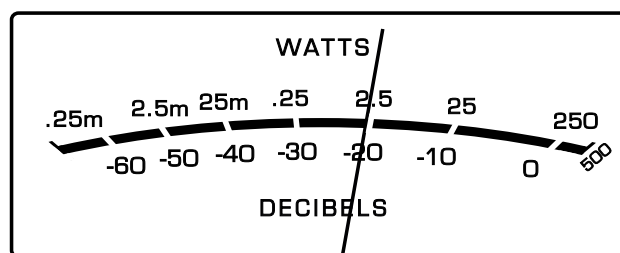

Figure 21

The meters respond to all the musical information being produced by the Amplifier. They indicate to an accuracy of at least 95% of the power output with only a single cycle of a 2,000Hz tone burst.

### Input Selector

Each of the four Power Amplifier Channels have a switch located on the rear panel for selection of the Input Source Signal. Refer to figure 22.

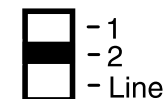

Figure 22

The Switch Position **1** is the Input Signal Source from the BUS 1 UNBALANCE Input Jacks (Left or Right Channel feed the same Power Amplifier Channel Type). The Switch Position **2** is the Input Signal Source from the BUS 2 unbalanced Input Jacks (Left or Right Channel feed the same Power Amplifier Channel Type). The Switch Position **LINE** is the Input Signal Source from the UNBALANCED or BALANCED Rear Panel Connectors for the same Channel where the switch is located. Refer to pages 6 and 7 for additional information.









## Specifications

### Power Output

Minimum sine wave continuous average power output per channel, all channels operating is:  
250 watts into a 8 ohm load  
300 watts into a 4 ohm load

### Output Load Impedance

8 and 4 ohms

### Rated Power Band

20Hz to 20,000Hz

### Total Harmonic Distortion

0.025% maximum harmonic distortion at any power level from 250 milliwatts to rated power, 20Hz to 20,000Hz

### Dynamic Headroom

2.5dB, 8 ohm load  
3.5dB, 4 ohm load

### Frequency Response

+0, -0.9dB from 20Hz to 20,000Hz

### Input Sensitivity for rated output (8 ohm load)

5.0 Volt Balanced  
2.5 Volt Unbalanced

### Input Sensitivity for rated output (4 ohm load)

3.8 Volt Balanced  
1.9 Volt Unbalanced

### Signal To Noise Ratio (A-Weighted)

83dB (100dB below rated output)

### Intermodulation Distortion

0.1% maximum, if the instantaneous peak power output does not exceed the rated power output for any combination of frequencies from 20Hz to 20,000Hz.

### Wide Band Damping Factor

Greater than 85, 8 ohm Load  
Greater than 45, 4 ohm Load

### Input Impedance

32,000 ohms Balanced  
18,000 ohms Unbalanced

### Voltage Gain

25dB

### Power Control Input

5-15VDC, less than 1mA

### Power Control Output

12VDC, 50mA maximum total

### Power Requirements

100 - 240Volts, 50/60Hz at 10 Amps  
Standby: less than 0.5 watt

### Overall Dimensions

Width is 17-1/2 inches (44.5cm)  
Width with Side Mount Brackets attached is 19 inches (48.3cm)  
Height is 4-5/16 inches (11.0cm) including feet  
Depth is 21 inches (53.3cm) including the Front Panel and Cables

### Weight

23.5 pounds (10.7 kg) net, 39.9 pounds (18.1 kg) in shipping carton

### Shipping Carton Dimensions

Width is 26-1/2 inches (67.3cm)  
Height is 11-3/4 inches (29.9cm)  
Depth is 24-1/4 inches (61.6cm)

**Packing Instructions**

In the event it is necessary to repack the equipment for shipment, the equipment must be packed exactly as shown below. It is very important that the four plastic feet are attached to the bottom of the equipment.

This will ensure the proper equipment location on the bottom pad. Failure to do this will result in shipping damage.

Use the original shipping carton and interior parts only if they are all in good serviceable condition. If a shipping carton or any of the interior part(s) are needed, please call or write Customer Service Department of McIntosh Laboratory. Refer to page 2. Please see the Part List for the correct part numbers.

Quantity	Part Number	Description
1	033838	Shipping carton only
2	033837	End cap
1	033836	Inside carton only
1	033725	Top pad
1	034576	Bottom pad
1	034592	Filler pad
2	034446	Foam plug
4	017937	Plastic foot
4	400159	#10-32 x 3/4" screw
4	404080	#10 Flat washer

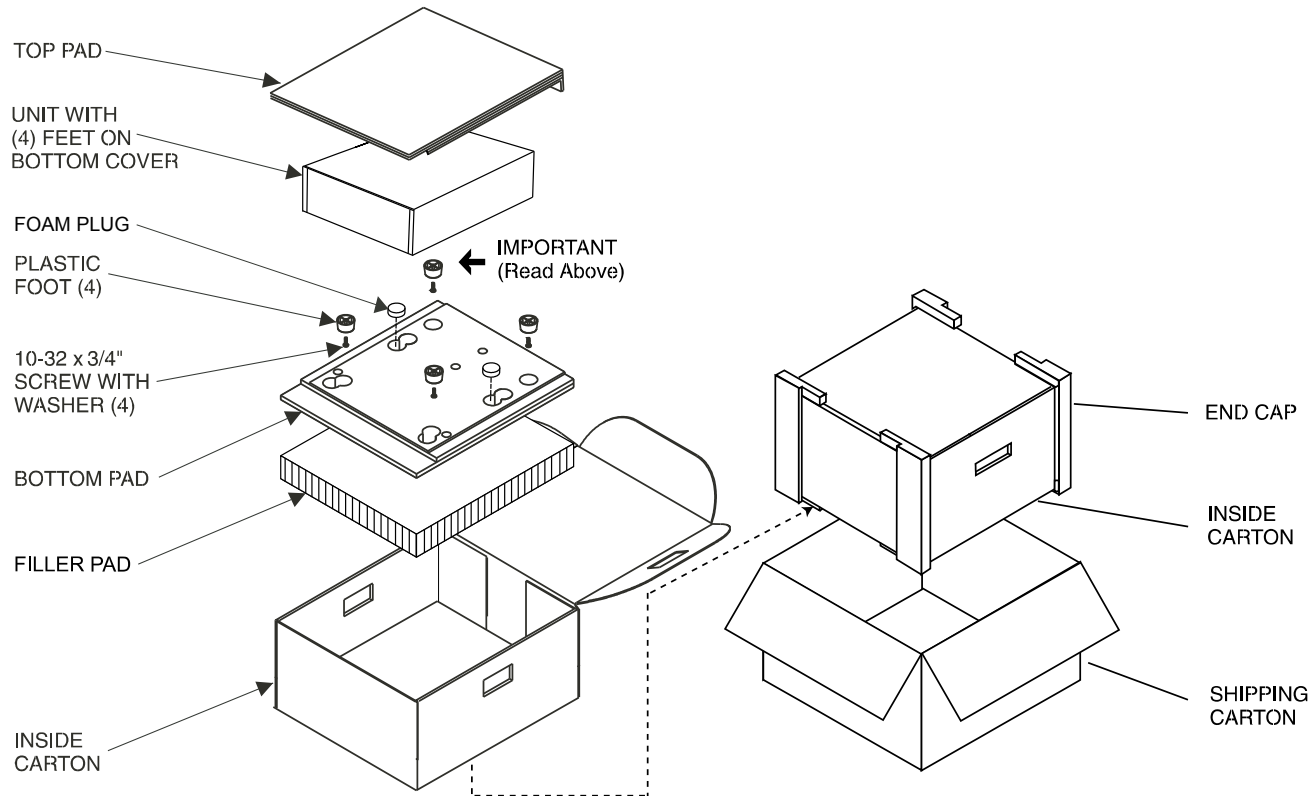



McIntosh Laboratory, Inc.  
2 Chambers Street  
Binghamton, NY 13903  
[www.mcintoshlabs.com](http://www.mcintoshlabs.com)

The continuous improvement of its products is the policy of McIntosh Laboratory Incorporated who reserve the right to improve design without notice.  
Printed in the U.S.A.