



McIntosh Laboratory, Inc. 2 Chambers Street Binghamton, New York 13903-2699 Phone: 607-723-3512 [www.mcintoshlabs.com](http://www.mcintoshlabs.com)

## RS150

Wireless Loudspeaker System

Owner's Manual



***Quick Start***  
*is on page 4*



---

## Safety First

---

It is a smart idea to read all the enclosed RS150 SAFETY INFORMATION included in separate documents; even if you already know this stuff, you can't be too safe.

Here is some compliance information:

---

## FCC Information (For US Customers)

---

### 1. IMPORTANT NOTICE: DO NOT MODIFY THIS PRODUCT

This product, when installed as indicated in the instructions contained in this manual, meets FCC requirements. Modification not expressly approved by McIntosh may void your authority, granted by the FCC, to use the product.

### 2. CAUTION:

- To comply with FCC RF exposure compliance requirement, separation distance of at least 20cm must be maintained between this product and all persons.
- This product and its antenna must not be co-located or operating in conjunction with any other antenna or transmitter.

### 3. COMPLIANCE INFORMATION:

- Product Name: RS150 Wireless Loudspeaker System
  - Model Number: RS150
  - This product contains FCC ID:2AJYB-S810
- McIntosh Laboratory, Inc.  
2 Chambers Street  
Binghamton, NY 13903  
Tel. (607) 723-3512

---

## IC Information (Canadian Customers)

---

### 1. PRODUCT:

This product contains IC: 20504-S810

This product complies with RSS-210 of Industry Canada. Operation is subject to the following two conditions:

(1) this product may not cause harmful interference, and (2) this product must accept any interference received, including interference that may cause undesired operation. This Class B digital Apparatus complies with Canadian ICES-003.

### 2. CAUTION:

To reduce potential radio interference to other users, the antenna type and its gain should be so chosen that the equivalent isotropically radiated power (e.i.r.p.) is not more than that permitted for successful communication.

## Informations sur IC (pour les clients Canadiens)

### 1. APPAREIL:

Cet Appareil contient IC: 20504-S810.

Cet Appareil est conforme à la norme CNR-210 du Canada. L'utilisation de ce dispositif est autorisée seulement aux deux conditions suivantes : (1) il ne doit pas produire de brouillage, et (2) l'utilisateur du dispositif doit être prêt à accepter tout brouillage radioélectrique reçu, même si ce brouillage est susceptible de compromettre le fonctionnement du dispositif. Cet Appareil numérique de la classe B est conforme à la norme NMB-003 du Canada.

### 2. ATTENTION:

Afin de réduire le risque d'interférence aux autres utilisateurs, il faut choisir le type d'antenne et son gain de façon à ce que la puissance isotrope rayonnée équivalente (p.i.r.e.) ne soit pas supérieure au niveau requis pour l'obtention d'une communication satisfaisante.

## Canadian Customers: CAN ICES-003 (B)/NMB-003 (B)

### RF Exposure Information

This equipment complies with FCC/IC radiation exposure limits set forth for an uncontrolled environment and meets the FCC radio frequency (RF) Exposure Guidelines in

Supplement C to OET65 and RSS-102 of the IC radio frequency (RF) Exposure rules. This equipment has very low levels of RF energy that are deemed to comply without testing of specific absorption ratio (SAR).

Cet équipement est conforme aux normes d'exposition aux radiations FCC/IC définies pour un environnement non contrôlé et satisfait les directives d'exposition à la radiofréquence (RF) dans le supplément C des OET65 et RSS-102 des règles d'exposition à la fréquence radio (RF) IC. Cet équipement a de très faibles niveaux d'énergie RF qui sont jugés conformes sans test de taux d'absorption spécifique (SAR).

## RED (EN) Information

### 1. DECLARATION OF CONFORMITY

Our products follow the provisions of EC/EU directives:

LVD: 2014/35/EU

EMC: 2014/30/EU

RED: 2014/53/EU

ERP: EC regulation 1275/2008 and its frame work directive 2009/125/EU

RoHS: 2015/863/EU

### 2. IMPORTANT NOTICE: DO NOT MODIFY THIS PRODUCT

This product, when installed as indicated in the instructions contained in this manual, meets RED directive requirements. Modification of the product could result in hazardous Radio and EMC radiation.

### 3. CAUTION:

Separation distance of at least 20cm must be maintained between this product and all persons.

This product and its antenna must not be co-located or operating in conjunction with any other antenna or transmitter.

---

## Table of Contents

Safety First.....	2
FCC Information (For US Customers) .....	2
IC Information (Canadian Customers) .....	2
Thank you from all of us at McIntosh .....	3
Make a Note.....	3
Trademark and License Information .....	4
Quick Start (Bluetooth) .....	4
More Connections.....	5
AirPlay 2 .....	5
Wi-Fi connection using an iOS Device .....	5
Ethernet.....	5
Setting up Wi-Fi Without Ethernet.....	5
Chromecast .....	5
Note About Initial Network Connection.....	6
Roon.....	6
Tidal Connect.....	6
Spotify Connect.....	6
Qualcomm® aptX™ Audio.....	6
Front View Labeled .....	7
Installing the Grille .....	7
The Knobs and LEDs on the Front.....	8
The Right Knob .....	8
The Left Knob .....	8
Network/Wi-Fi Indicator LED .....	8
Automatic Input Select .....	8
Sleep Mode LED.....	8
Input Indicators.....	8
Rear View Labeled .....	9
Rear Connections.....	9
Ethernet Port.....	9
AC Connector .....	9
USB Service Port.....	9
The Browser Interface .....	10
OVERVIEW Menu.....	10
SETTINGS Menu .....	11
UPDATE Menu.....	12

Re-packing the RS150 .....	13
Dimensions .....	14
Technical Specifications .....	15

## List of Figures

Figure 1– AC Power Cord.....	4
Figure 2– Scan for bluetooth devices .....	4
Figure 3– Ethernet connection .....	5
Figure 4– Front View .....	7
Figure 5– Installing the Grille.....	7
Figure 6– Rear View .....	9
Figure 7– OVERVIEW submenu .....	10
Figure 8– SETTINGS submenu .....	11
Figure 9– UPDATE submenu.....	12
Figure 10– Packing Material .....	13
Figure 11– Dimensions .....	14

---

## Thank you from all of us at McIntosh

Your new RS150 Wireless Loudspeaker System is a precision instrument that will provide many years of enjoyment. Please take a few moments to familiarize yourself with the features and instructions to get the maximum performance from your equipment.

If you need further technical assistance, please contact your dealer who may be more familiar with your particular setup including other brands. You can also contact McIntosh with additional questions or in the unlikely event of needing service.

### McIntosh Laboratory, Inc.

2 Chambers Street  
Binghamton, New York 13903  
Technical Assistance Phone: (607) 723-3512  
Customer Service (for repairs)  
Phone: (607) 723-3515  
Fax: (607)-724-1917  
support@mcintoshlabs.com  
Website: mcintoshlabs.com

---

## Make a Note





For future reference, you can jot down your serial number and purchase information here. We can identify your purchase from this information if the occasion should arise. The serial number is located on the back label of the RS150.



Serial Number:	
Purchase Date:	
Dealer Name:	



## Trademark and License Information

The McIntosh RS150 incorporates copyright protected technology that is protected by U.S. patents and other intellectual property rights. The RS150 uses the following Technologies:

Trademark Logo	License Information
	Use of the Works with Apple badge means that an accessory has been designed to work specifically with the technology identified in the badge and has been certified by the developer to meet Apple performance standards. Apple, iPad, iPad Air, iPad Pro, iPhone and AirPlay are trademarks of Apple Inc., registered in the U.S. and other countries. To control this AirPlay 2-enabled speaker, iOS 11.4 or later is required.
	The Bluetooth® word mark and logos are registered trademarks owned by Bluetooth SIG, Inc. and any use of such marks by McIntosh Group, Inc. is under license. Other trademarks and trade names are those of their respective owners.
	Qualcomm aptX is a product of Qualcomm Technologies, Inc. and/or its subsidiaries. Qualcomm is a trademark of Qualcomm Incorporated, registered in the United States and other countries. aptX is a trademark of Qualcomm Technologies International, Ltd., registered in the United States and other countries.
	The Wi-Fi CERTIFIED logo is a registered trademark of the Wi-Fi Alliance. Wi-Fi Certification provides assurance that the device has passed the interoperability test conducted by the Wi-Fi Alliance, a group that certifies interoperability among wireless LAN devices.
	Roon Ready network devices have Roon's streaming technology built in, and are certified by Roon Labs to provide the highest level of quality and performance in network streaming.

Trademark Logo	License Information
	TIDAL is the first global music streaming service with high fidelity sound, hi-def video quality, along with expertly curated playlists and original content — making it a trusted source for music and culture.
	The Spotify software is subject to third party licenses found here: <a href="https://developer.spotify.com/esdk-third-party-licenses">https://developer.spotify.com/esdk-third-party-licenses</a> . CONNECT UPDATE
	Chromecast built-in is a trademark of Google LLC.

## Quick Start (Bluetooth)

Here are the basic steps to start enjoying the RS150 Wireless Loudspeaker System right away. This Quick Start will get sound flowing from the RS150 via a Bluetooth connection. That way you can hear some music as you read the rest of this manual.

- Connect to the RS150 to AC Power. See Figure 1

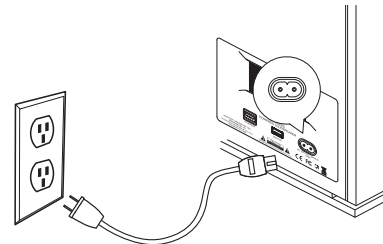

Figure 1– AC Power Cord

- Power the RS150 On by pressing and releasing the Right Knob
- The BT above the Left Knob will Flash. If it is no longer flashing, press and hold the Left Knob for two seconds and then release
- On the phone (or other device) you wish to

connect, press SCAN in the Bluetooth section of Settings. Generally, this is found in the Connections' submenu of settings (devices may vary)

### Settings>Connections>Bluetooth

- The RS150 will appear as “RS150 xxxx” in Available Devices. See Figure 2

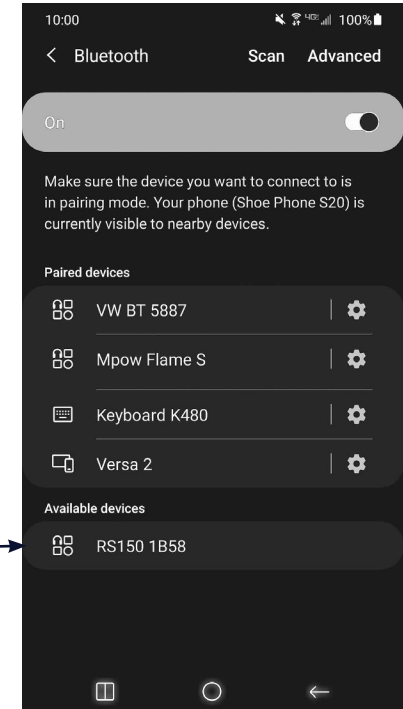

Figure 2– Scan for bluetooth devices

- Choose the RS150 to pair
- When asked to confirm you want to pair the RS150 to your device, select OK
- The RS150 should now be “Connected for audio”
- Play some music

---

## More Connections

---

### AirPlay 2

AirPlay 2 is an Apple technology designed to control home audio systems and speakers in any room – with a tap or by simply asking Siri – right from iPhone, iPad, HomePod or Apple TV.

To control this AirPlay 2-enabled speaker, iOS 11.4 or later is required.

### Multiroom Audio

AirPlay 2 technology lets you play a song on every RS150 in your house at the same time or adjust the volume in any room – all in sync.

After installing your RS150, add it to the Apple Home App with a few simple steps using your iPhone or iPad.

### Siri Voice Control

Use Siri on your iPhone, iPad, HomePod, or Apple TV to control your RS150 with just your voice.

### Wi-Fi connection using an iOS Device

Setting up the RS150 as a AirPlay Speaker will connect the RS150 to your Wi-Fi network:

- Make sure your iOS device is on the Wi-Fi network you wish to connect the RS150 to
- With the RS150 powered on, the LED below the Left Knob should not be solidly illuminated green (if it were lit, it would indicate the RS150 is currently connected to a network)
- Open up Settings on the iOS device
- Open up the Wi-Fi submenu
- Look at the Wi-Fi network list and find “Set Up New AirPlay Speaker”

- Select the RS150
- The RS150 will be added to your network

### Ethernet

For a wired connection to your network, use an Ethernet cable to connect the RS150 to your router. See Figure 3.

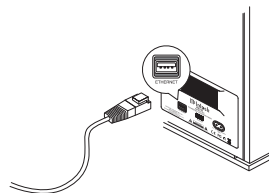

Figure 3– Ethernet connection

Note: a solid red Network/Wi-Fi LED indicates that a network error has occurred. See “Network/Wi-Fi Indicator LED” on page 8.

Note that plugging in an ethernet cable will disable the Wi-Fi radio of the RS150. The RS150 will use the ethernet connection for all network activity. To enable Wi-Fi, the ethernet cable must be removed.

With an ethernet connection, you can use the RS150 browser interface to provide the RS150 with your Wi-Fi settings. For more information, see “The Browser Interface” on page 10.

### Setting up Wi-Fi Without Ethernet

To initially connect your RS150 to a Wi-Fi network without using an ethernet connection or iOS connection (as described above) follow these steps:

- Power the RS150 Off and then On
- When the green LED below the Left Knob is blinking, open your PC or phone’s Wi-Fi Connection Settings
- Locate the RS150 in the list of available networks and connect to it.
- Open a web browser (Chrome or Firefox)

- Type 192.168.255.249 in the browser’s address bar and open that page
- Select SETTINGS from the RS150 interface (see Figure 8 on page 11)
- Select Wireless in Network Type
- Select Start Scan
- Select your network
- Provide your password and press Connect
- Your RS150 will connect to your network

### Chromecast

To Cast to your RS150, you will need:

- The latest version of Google Home App
- Wireless network and access password

With your mobile device/tablet connected to the same Wi-Fi network as your RS150 and the RS150 powered on:

- Open the Google Home App
- Follow the steps for the RS150 if they automatically appear

To manually add the RS150

- Tap the **+** at the top of the screen
- Select “Set up device”
- Select “Setup new devices”
- Follow the set up steps for a “Speaker”

Once the RS150 is setup, you can choose to Cast to it. To Cast:

- Choose the Cast button in the top right corner of a Chromecast-enabled app
- Choose the RS150
- When connected the Cast button will change colors
- Cast music, etc. to your RS150



## Note About Initial Network Connection

When your RS150 connects to your network for the first time, it will automatically look for the latest software update. If available, the RS150 will install the newest version. When updating, the Red LED below the Right Knob will blink twice, pause and repeat.

You may adjust how future updates are handled. See “UPDATE Menu” on page 12.

## Roon

When connected to your network, the RS150 will be available as a Zone for your Roon server. (If you have a Roon server.) The RS150 can be connected to your Wi-Fi using AirPlay (see “Wi-Fi connection using an iOS Device” on page 5) or Chromecast. It can also be directly connected with an ethernet cable.

## Tidal Connect

To listen to music on TIDAL through the RS150, using the Tidal app, select the content you want to play and then select the connect icon  on the Now Playing page.

This will bring up a list of nearby devices to stream through. Locate the RS150 and select to pair.

If you are unable to find your device, make sure the device is connected to the same Wi-Fi network you are streaming from.

Once paired you can use your TIDAL app as a remote. TIDAL is compatible with select smart assistants that enable voice controls. Depending on your region, you may enable this feature by linking your TIDAL account with your selected smart device. This option can normally be found in the

Settings section of your respective Smart Devices app.

## Spotify Connect

Use your phone, tablet or computer as a remote control for Spotify. Go to [spotify.com/connect](https://spotify.com/connect) to learn how.

## Qualcomm® aptX™ Audio

aptX™ is a codec that can provide CD quality music over Bluetooth connections. The RS150 will automatically utilize aptX when connected to a source that supports aptX. Simply connect with Bluetooth as described in “Quick Start (Bluetooth)” on page 4.

The RS150 also supports the higher resolution aptX HD (24-bit/48kHz). If your device utilizes aptX HD then that resolution will be utilized automatically.

The RS150 also features aptX LL (Low Latency) which automatically ensures Bluetooth can deliver sound in sync with visual media. It reduces delay and improves end-to-end speed of the audio transmission, resulting in a high quality, synchronized user experience with any transmitting device that supports aptX LL.

## Front View Labeled

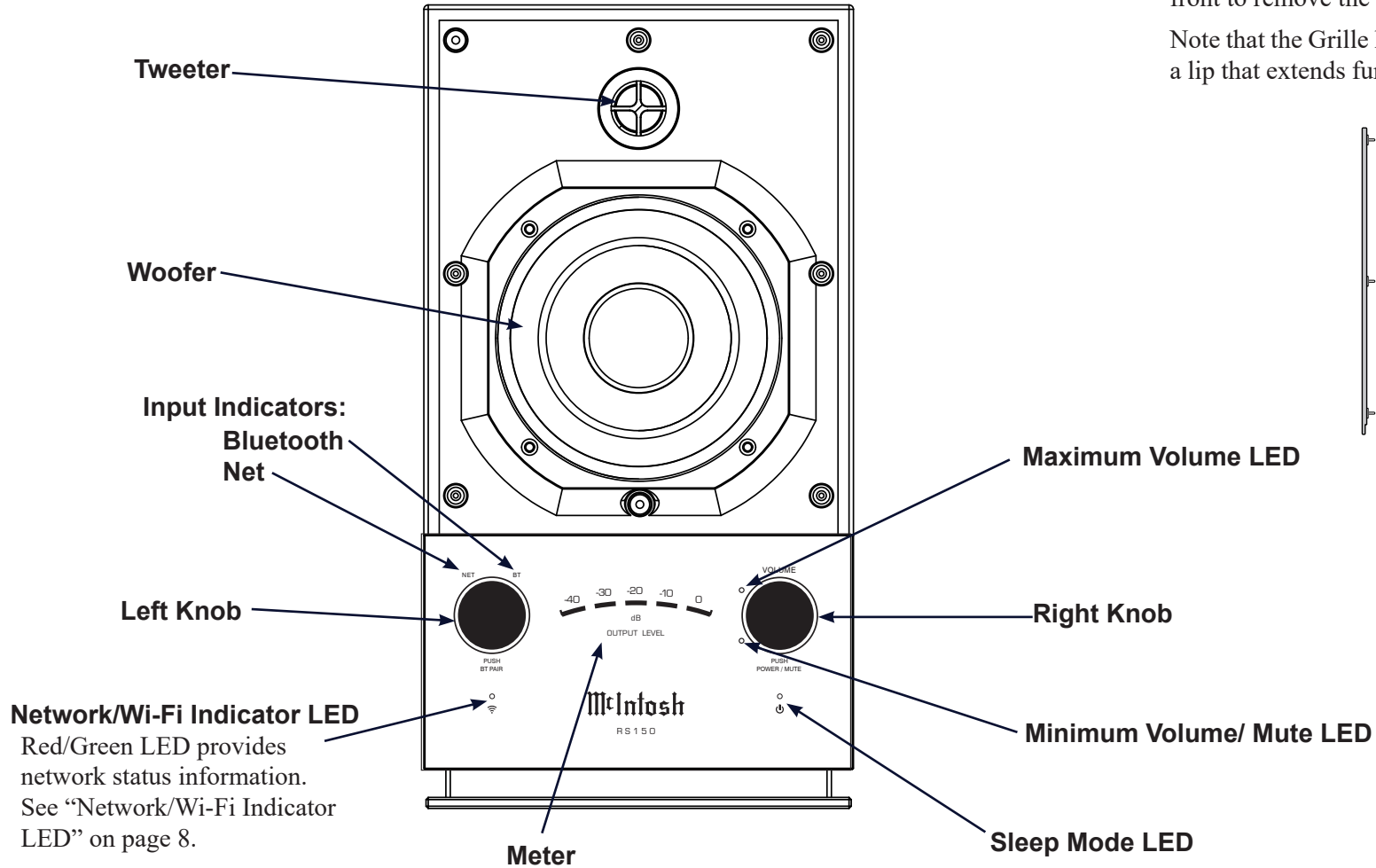

Figure 4– Front View

## Installing the Grille

The RS150’s Grille can be installed by lining up the eight plastic pegs on the back of the Grille with the eight holes framing the speakers of the RS150. Gently push with even pressure to install and pull straight away from the front to remove the Grille. See Figure 5 below.

Note that the Grille has a top and bottom. The bottom has a lip that extends further from the pegs than the top does.

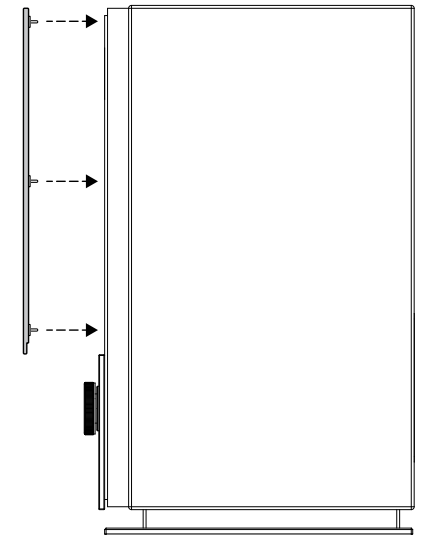

Figure 5– Installing the Grille



## The Knobs and LEDs on the Front

### The Right Knob

The Right Knob is primarily the Volume and Power Knob.

Command	Right Knob Action
Raise Volume	Rotate clockwise
Lower Volume	Rotate counter clockwise
Mute/ Pause	Short press (less than half a second)
Unmute/Play	Short press (less than half a second) or rotate in either direction
Adjust Bass Level	Press and Hold while turning clockwise to increase the Bass Level and counter clockwise to decrease. The Meter will graphically show the level as adjusted. The midpoint on the meter is considered neutral
Enter Sleep State (power down)	Press and Hold for two seconds
Wake from Sleep State (power up)	Short Press

### The Left Knob

The Left Knob can be used to adjust lighting levels and to place the RS150 in Discovery Mode.

Command	Left Knob Action
Adjust Lighting	Press and Hold while turning clockwise to increase the lighting level and counter clockwise to decrease. The Meter will graphically show the level as adjusted
Enter Bluetooth Discovery Mode	Press and Hold for two seconds
Sleep Mode Lighting	Within two seconds of entering Sleep State (see “The Right Knob” above), turn the Left Knob to toggle the Meter Lighting on/off

### Network/Wi-Fi Indicator LED

When connected to a network, the Network/Wi-Fi indicator LED will be glow a solid green. For network states, see the table below:

LED	Status
Green- slow pulse	RS150 is in process of joining the network
Green- solid	Connected to the network
Red- solid	a network error has occurred
Red- slow pulsing	there is a critical firmware issue. Please upgrade firmware

### Automatic Input Select

There is no Input Select Knob. Input selection is automatic. There is a hierarchy of input types. A Wi-Fi connection will take precedence over a Bluetooth connection. If there is no Wi-Fi connection present, Bluetooth connection is automatic.

If a Bluetooth connection is interrupted then it must be re-established from the mobile device.

### Sleep Mode LED

The LED will glow red when the RS150 is connected to a live AC outlet and the unit is in Sleep Mode. When the RS150 receives a power on command, the Sleep Mode LED will turn off.

### Input Indicators

When a network streaming session is active, the NET light will be lit.

When a Bluetooth connection is established, the BT LED will be solidly lit. The BT flashing indicates that the RS150 is in Bluetooth discovery mode.



## Rear View Labeled

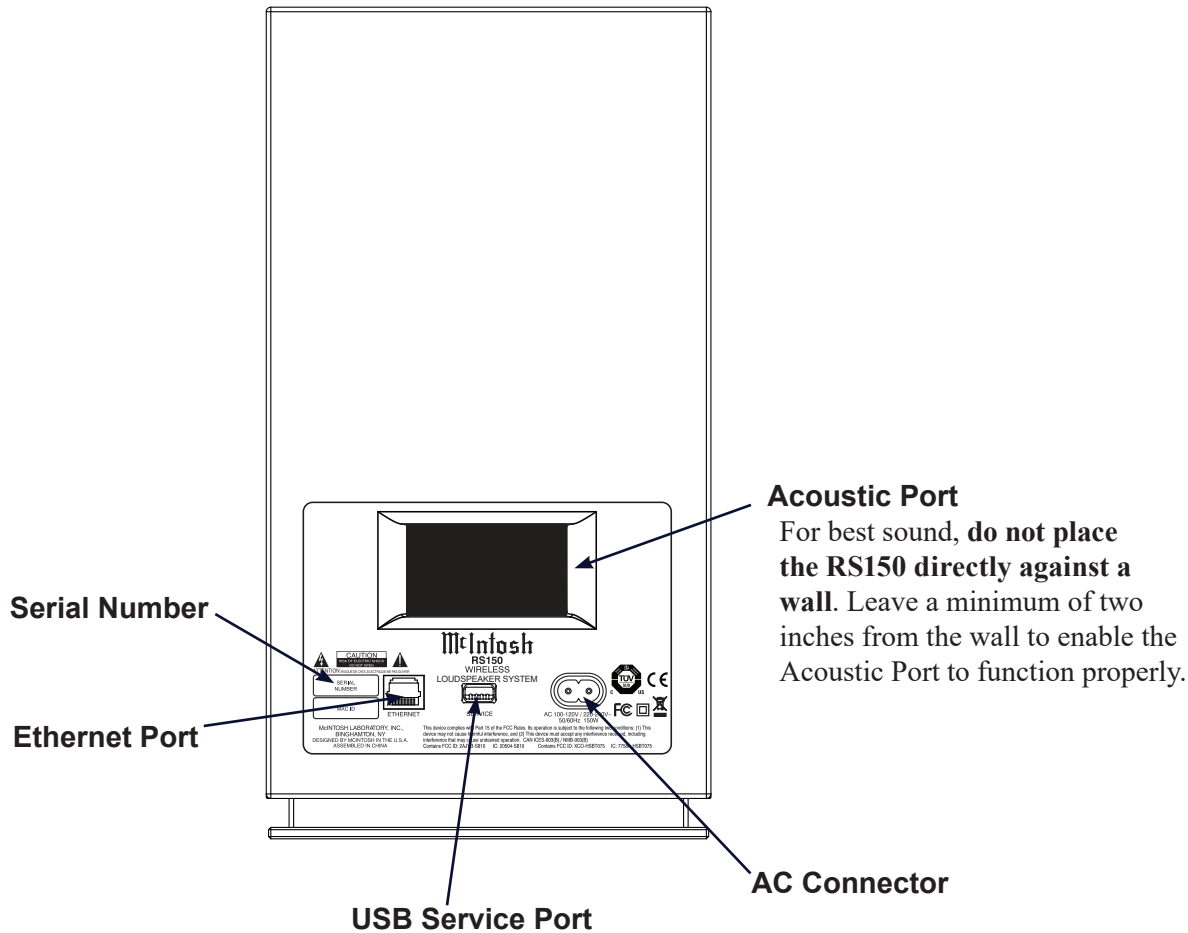

Figure 6– Rear View

## Rear Connections

### Ethernet Port

The Ethernet Port connects your RS150 to your network’s router using a standard CAT5, CAT5E or CAT6 cable with an RJ45 connector. Using a wired connection is one way to access the RS150’s setup via a browser. For more information, see “The Browser Interface” on page 10.

### AC Connector

Use the supplied AC Power Cord to connect the RS150 to a live AC outlet.

### USB Service Port

The USB port is only for performing service functions by a qualified service technician. It is not intended for USB device support or playback.

## The Browser Interface

To view the RS150's browser interface, you will need its IP address.

There are several ways to find a device's IP address. For instance, you can use IP scanner software. Here is one way with out additional software. To find the RS150's IP address:

With the RS150 connected to your network with a wired or wireless connection:

- Type the IP address of your router into the address bar of a browser (often 192.168.1.1)
- Enter the router's Username and password. (The default can be found in the router's documentation, but changing it is a good security rule)
- Look for the RS150 in the list of wired or wireless clients for your router
- Note the IP address

With the RS150's IP address:

- **Type the address of the RS150 into the address bar of your router**

The RS150 Browser interface has three submenus:

- OVERVIEW
- SETTINGS
- UPDATE

Click on the desired heading to enter that menu.

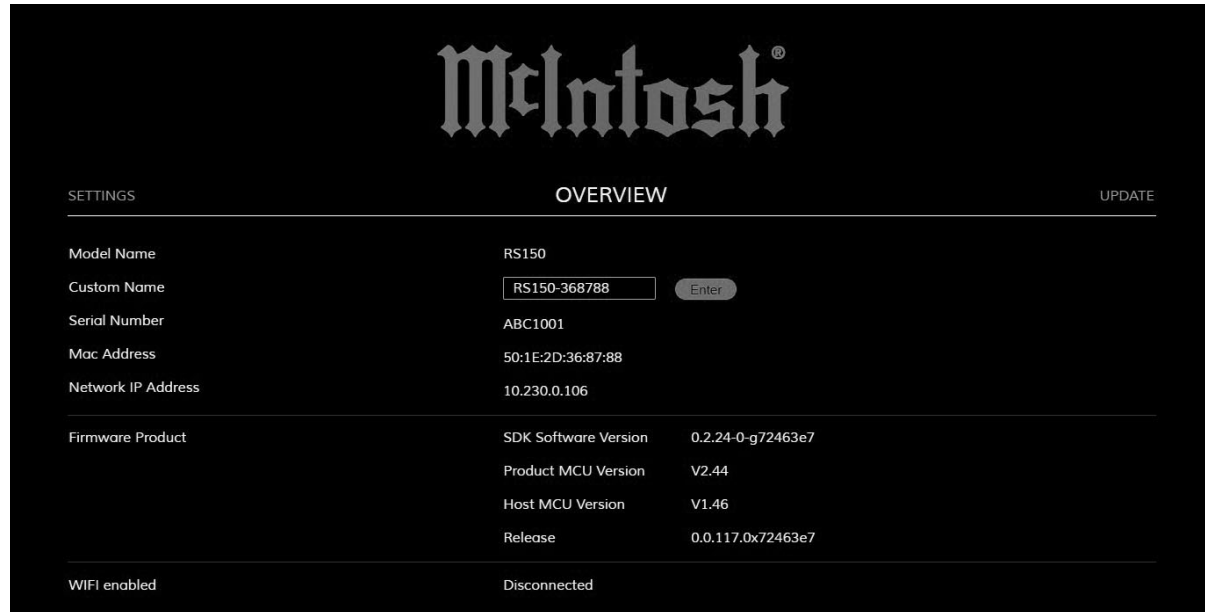

Figure 7– OVERVIEW submenu

### OVERVIEW Menu

The Overview menu provides the following information about the RS150:

- Serial Number
- MAC Address
- Network IP Address
- Firmware versions

You can provide a Custom Name for the RS150. This is the name that will display for available AirPlay devices. If you wish to change the default name, type the new name in the box and press Enter.

The Overview Menu provides an indicator for the status of your Wi-Fi (WIFI enabled). When enabled the indicator will show ON and be green. An ethernet connection takes precedence and will automatically disable Wi-Fi. Wi-Fi, if set up, will re-engage when the ethernet cable is disconnected.

### SETTINGS Menu

The **Power Sleep Timer** has two settings:

- ON (default)
- OFF

When the Power Sleep Timer is set to ON, the RS150 will power off into a sleep state after approximately 30 minutes of no sound or user input. After 60 minutes of uninterrupted sleep, the RS150 will enter a Standby Mode. In this Standby Mode, the Wi-Fi radio is powered off and the unit can not be woken via the network. Standby Mode power consumption is less than 0.5 watts.

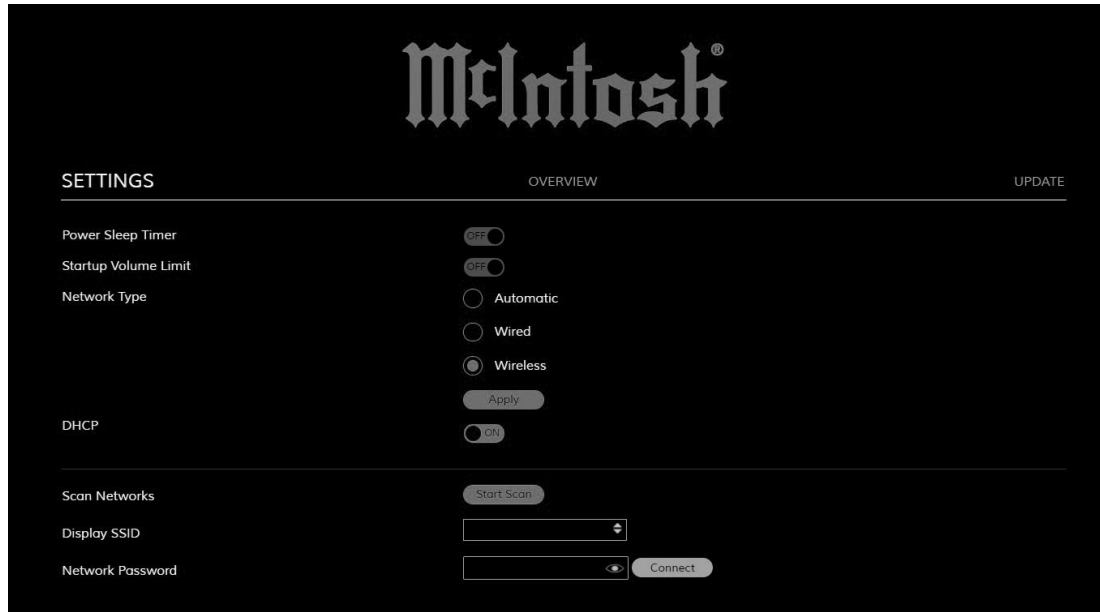

Figure 8– SETTINGS submenu

If the Power Sleep Timer is set to OFF, the RS150 will power off into a sleep state after 30 minutes of non-activity. The RS150 can be woken from sleep by input from the network (or physically pushing the Power Button). In a sleep state, the RS150 will continue to work with devices configured to control it in your Google Home collection.

The RS150 can be made to immediately enter a sleep state by pressing and holding the Right Knob for two seconds. If Power Sleep Timer is set to ON, the RS150 will enter Standby Mode after 60 minutes of uninterrupted sleep.

The **Startup Volume Limit** has two settings:

- ON
- OFF (default)

When the Startup Volume Limit is ON, upon power loss or return to play from Sleep or Standby, the first playback of the product will start at a low volume level. When switched to OFF, the product will resume playback at the last volume level.

The **Settings Menu** allows you to change settings for Wired and Wireless network connections.

Select **Network Type** to see/change settings:

- Automatic
- Wired
- Wireless

If Network Type is set to Automatic, the RS150 will

automatically connect to Wi-Fi when the ethernet cable is unplugged provided the Wireless connection has previously been setup. Selecting Wired for Network Type will limit the RS150 network connection to the ethernet port connection. Select Wireless to setup a Wi-Fi network or to restrict the network connection to Wi-Fi.

If you selected the Network Type of Wireless, the following submenus appear:

- Scan Networks
- Display SSID
- Network Password

**To set up a wireless connection for the RS150:**

- Select Start Scan
- In the Display SSID submenu, select a wireless network using the up/down arrows
- Enter the Network Password for that Network
- Select Connect

**DHCP** can be set to ON (Default) or OFF. If you change this setting to OFF, you will need to provide the following information manually:

- IP
- Netmask
- Gateway
- DNS (1st and 2nd)

With DHCP ON, this information is automatically acquired and the submenus to enter the information are not visible.

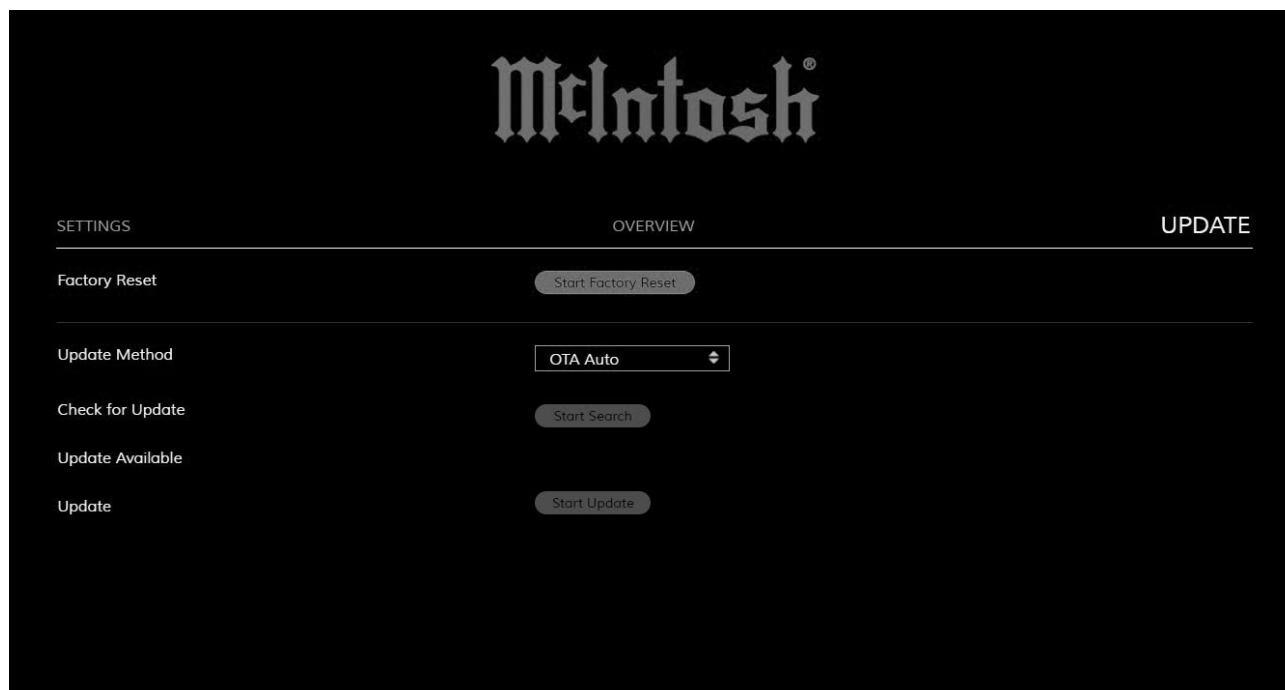

Figure 9– UPDATE submenu

## UPDATE Menu

The UPDATE menu allows you to reset settings to the factory defaults as well as update your RS150.

To restore Factory settings, select the “**Start Factory Reset**” button. Done. Note that you will lose your Wi-Fi settings.

An alternative method for Factory Reset, is to Press and Hold the Left and Right Knobs for 10 seconds.

**Update Method** allows you to set how the RS150 updates its firmware. When set to the default of **OTA Auto**, the RS150 will periodically check for updates and install them automatically. When set to **OTA Manual**, the RS150 will check for available updates when you select the **Start Search** button to the right of **Check for Update**. If an update is available, you

can install it by selecting **Start Update**. (OTA stands for “over-the-air”.)

The **Service** option for updating is for service purposes by a McIntosh qualified technician only.

While the RS150 is in the process of updating the firmware, the power status LED will blink twice in quick succession, pause for 2 seconds, and then repeat during the entire process.

## Re-packing the RS150

When shipping the RS150, it is highly recommended that the unit be packed as it was originally shipped to avoid damage. Failure to properly pack the unit will likely result in damage. If you need any of the packing material, you can contact McIntosh Customer Service.

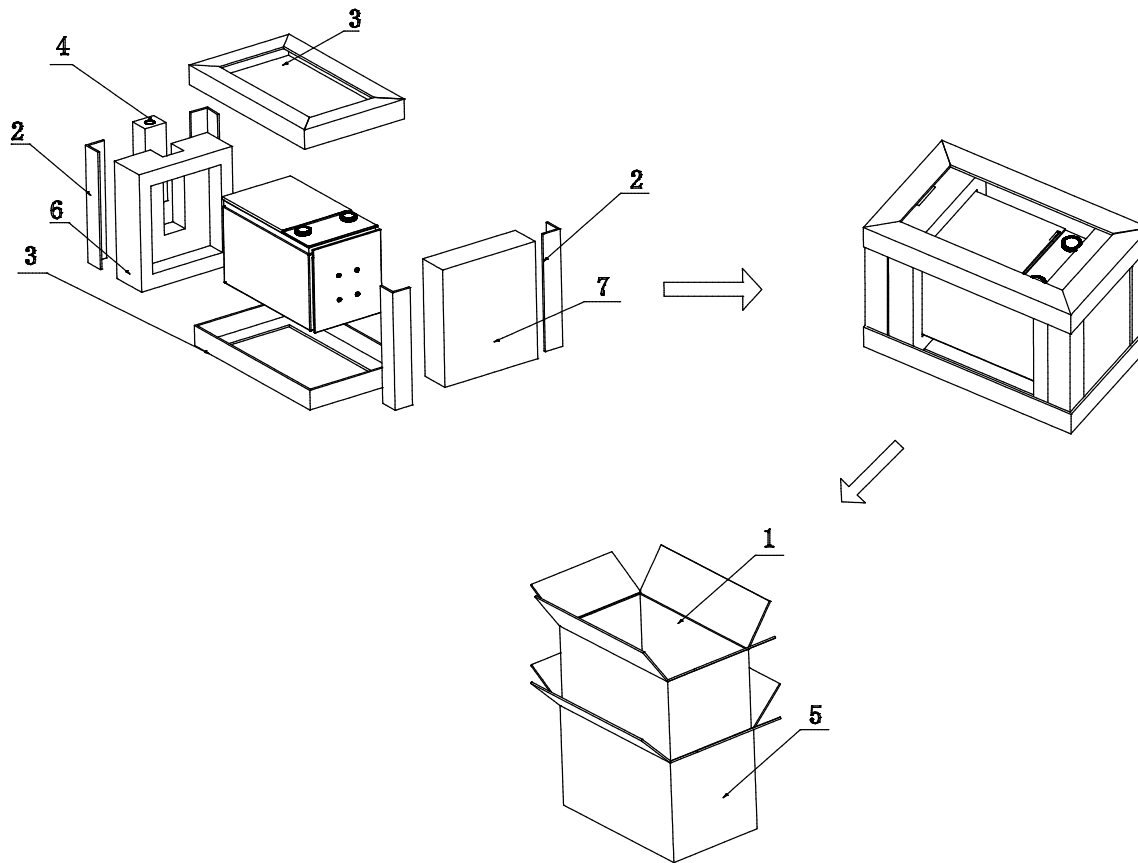

Item	QTY	Description	Part #
1	1	Inner Carton	310761SP
2	4	Paper Protector 1	310762SP
3	2	Paper Protector 2	310763SP
4	1	Accessory Box	310764SP
5	2	Outer Carton	310765SP
6	1	Left Foam	310766SP
7	1	Right Foam	310767SP

Figure 10– Packing Material



## Dimensions

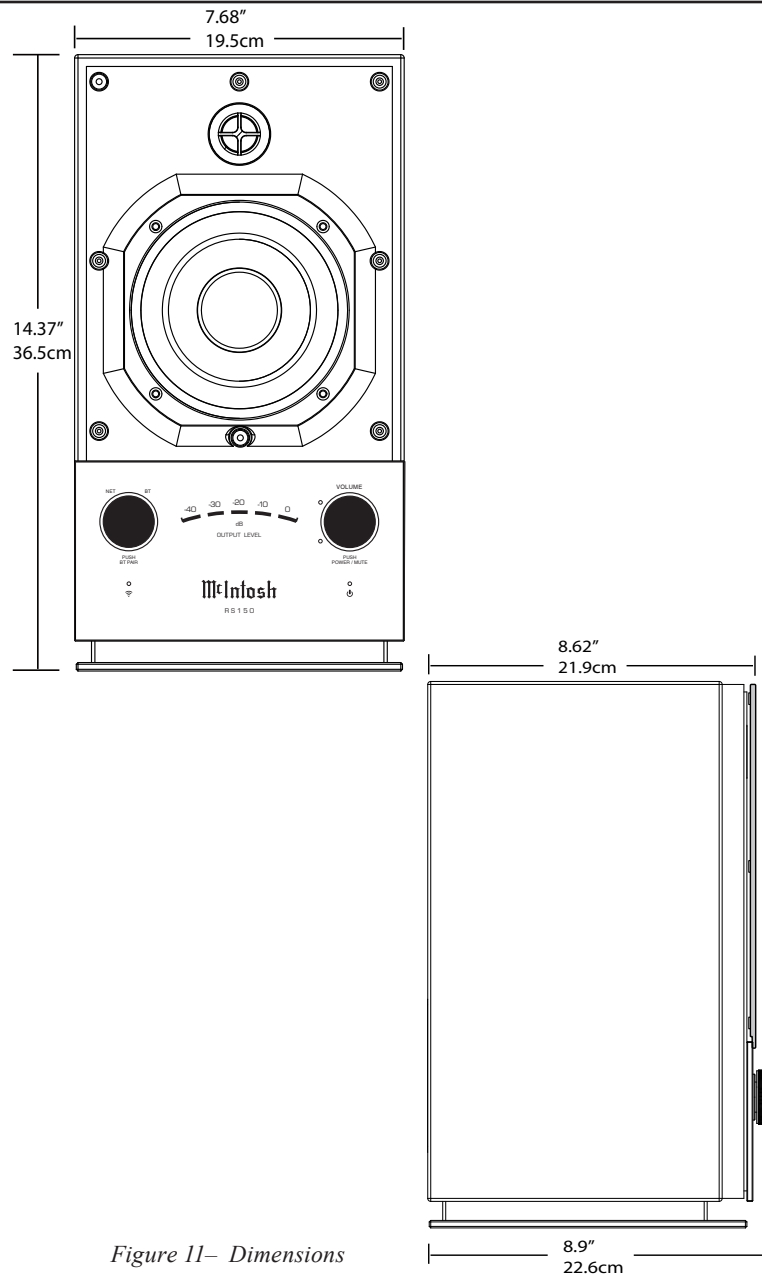

Figure 11– Dimensions

---

## Technical Specifications

---

### Power Output

120W: 30W Tweeter, 90W Woofer

### Speakers

One 20mm Titanium Dome Fluid-filled Tweeter

One 5-1/4 inch Long Throw Woofer

### Crossover Frequencies

2,000Hz

### Overall Frequency Range

48Hz to 20,000Hz

### Streaming Support

Apple AirPlay 2, Google Chromecast, Spotify

Connect, Tidal Connect, Roon

### Supported Audio Formats

(Must also be supported by chosen source app and device) MP3, AAC, FLAC, ALAC, WMA, Ogg Vorbis, WAV, M4A, OGG, AIFF

### Connectivity

Wi-Fi CERTIFIED™ a, b, g, n, ac

WPA™, WPA2™, WMM®

2.4/5 GHz, ethernet

### Bluetooth 5.0

AVRCP, A2DP, aptX, aptX HD, aptX LL

### Power Requirements

100-120V/220-240V ~ 50/60 Hz 150 Watts

### Dimensions

Width 7 11/16 inches (19.5cm)

Height 14 3/8 inches (36.8cm)

Depth 8 5/8 inches (21.9cm)

### Shipping Carton Dimensions:

Width 12 3/4 inches (32.4cm)

Height 20 inches (50.8cm)

Depth 14 3/8 inches (36.5cm)

### Weight

18.5 pounds (8.4kg) net

24.0 pounds (10.9kg) in shipping carton



The continuous improvement of its products is the policy of McIntosh Laboratory Incorporated who reserve the right to improve design without notice. The RS150 is designed to employ non-McIntosh-provided services some of which require separate customer subscriptions and some of which do not, as part of the Product's functionality. Because McIntosh cannot control the providers of such services or the services themselves, the owner of the Product therefore assumes all risks related to the use of services provided by anyone other than McIntosh itself. McIntosh cannot and does not warrant against, and shall have no liability of any kind for any of the following that are attributable to non-McIntosh providers or services: (i) interruption, discontinuance, or other unsatisfactory performance of service; (ii) reduced Product functionality that is so attributable; or (iii) any other loss or damage of any kind that is so attributable.